

Simulink[®] Report Generator[™] 3

User's Guide

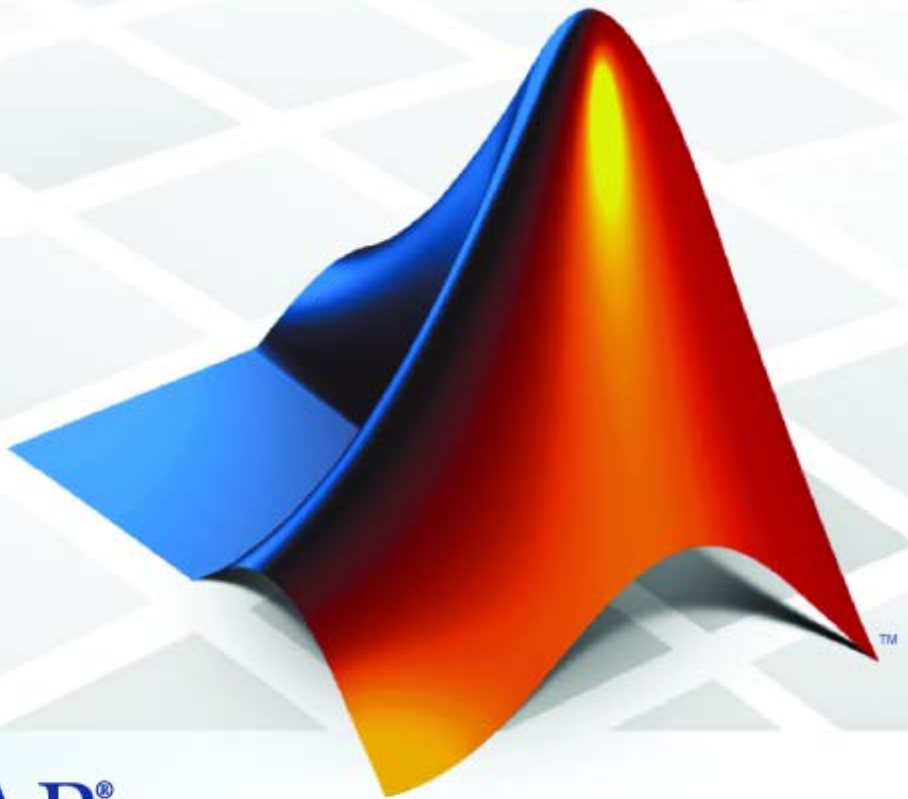

MATLAB[®]
& **SIMULINK[®]**

How to Contact The MathWorks



www.mathworks.com Web
comp.soft-sys.matlab Newsgroup
www.mathworks.com/contact_TS.html Technical Support



suggest@mathworks.com Product enhancement suggestions
bugs@mathworks.com Bug reports
doc@mathworks.com Documentation error reports
service@mathworks.com Order status, license renewals, passcodes
info@mathworks.com Sales, pricing, and general information



508-647-7000 (Phone)



508-647-7001 (Fax)



The MathWorks, Inc.
3 Apple Hill Drive
Natick, MA 01760-2098

For contact information about worldwide offices, see the MathWorks Web site.

Simulink® Report Generator™ User's Guide

© COPYRIGHT 1999–2009 by The MathWorks, Inc.

The software described in this document is furnished under a license agreement. The software may be used or copied only under the terms of the license agreement. No part of this manual may be photocopied or reproduced in any form without prior written consent from The MathWorks, Inc.

FEDERAL ACQUISITION: This provision applies to all acquisitions of the Program and Documentation by, for, or through the federal government of the United States. By accepting delivery of the Program or Documentation, the government hereby agrees that this software or documentation qualifies as commercial computer software or commercial computer software documentation as such terms are used or defined in FAR 12.212, DFARS Part 227.72, and DFARS 252.227-7014. Accordingly, the terms and conditions of this Agreement and only those rights specified in this Agreement, shall pertain to and govern the use, modification, reproduction, release, performance, display, and disclosure of the Program and Documentation by the federal government (or other entity acquiring for or through the federal government) and shall supersede any conflicting contractual terms or conditions. If this License fails to meet the government's needs or is inconsistent in any respect with federal procurement law, the government agrees to return the Program and Documentation, unused, to The MathWorks, Inc.

Trademarks

MATLAB and Simulink are registered trademarks of The MathWorks, Inc. See www.mathworks.com/trademarks for a list of additional trademarks. Other product or brand names may be trademarks or registered trademarks of their respective holders.

Patents

The MathWorks products are protected by one or more U.S. patents. Please see www.mathworks.com/patents for more information.

Revision History

January 1999	First printing	New (Release 11)
December 2000	Second printing	Revised (Release 12)
June 2004	Third printing	Revised for Version 2.02 (Release 14)
August 2004	Online only	Revised for Version 2.1
October 2004	Online only	Revised for Version 2.1.1 (Release 14SP1)
December 2004	Online only	Revised for Version 2.2 (Release 14SP1+)
April 2005	Online only	Revised for Version 2.2.1 (Release 14SP2+)
September 2005	Online only	Revised for Version 2.3.1 (Release 14SP3)
March 2006	Online only	Revised for Version 3.0 (Release 2006a)
September 2006	Online only	Revised for Version 3.1 (Release 2006b)
March 2007	Fourth printing	Revised for Version 3.2 (Release 2007a)
September 2007	Fifth printing	Revised for Version 3.2.1 (Release 2007b) This publication was previously for MATLAB® and Simulink®. It is now for Simulink® only.
March 2008	Online only	Revised for Version 3.3 (Release 2008a)
October 2008	Online only	Revised for Version 3.4 (Release 2008b)
October 2008	Online only	Revised for Version 3.5 (Release 2008b+)
March 2009	Online only	Revised for Version 3.6 (Release 2009)

Getting Started

1

Product Overview	1-2
What Is the Report Explorer?	1-3
About the Report Explorer	1-3
The Outline Pane	1-5
The Options Pane	1-6
The Properties Pane	1-7
Simulink® Report Generator Workflow	1-9
How Simulink® Report Generator and Simulink Software Interact	1-10
Supported Report Formats	1-11
Browser Requirements for Web Views	1-12

Creating Simulink Reports

2

About This Tutorial	2-2
Setting Report Options in the Report Template	2-3
Adding Components to the Report Template	2-5
What Are Components?	2-5
Adding MATLAB Code	2-7
Adding a Title Page	2-13
Opening the Simulink Model	2-16

Adding Logical Then and Logical Else Components	2-18
Displaying an Error When the Model Cannot Be Opened ..	2-19
Creating the Body of the Report	2-22
Generating the Report	2-49

Generating Reports

3

Setting Report Output Options	3-2
Setting Preferences	3-2
Setting the Report File Directory	3-3
Setting the Report File Name	3-4
Setting the Report Format	3-4
Viewing and Printing Reports	3-8
Converting English Strings to Other Languages	3-9
Autosaving Report Templates	3-9
Regenerating Images	3-9
Including a Report Description	3-9
Converting XML Documents	3-11
Why Convert XML Documents?	3-11
Converting XML Documents Using the Report Explorer ..	3-11
Converting XML Documents Using the Command Line ..	3-13
Editing XML Source Files	3-13
Creating Log Files	3-14
Generating M-Code from Report Templates	3-15
Working with Legacy Report Templates	3-18
What Are Legacy Report Templates?	3-18
Enabling Legacy Interfaces	3-18
Using Legacy Interfaces	3-19
Troubleshooting	3-20
Managing Memory Usage	3-20
Displaying HTML Reports on UNIX Systems	3-21

Exporting Simulink Models to Web Views

4

What Are Web Views?	4-2
Exporting Models to the Web	4-3
Opening the Export Interface	4-3
Setting Export Options	4-3
Generating and Reviewing Web Views	4-5
Navigating Web Views	4-7
Displaying Web Views	4-7
Viewing the Current Layer	4-7
Viewing Other Layers	4-8
Viewing All Layers	4-9
Tutorial: Creating Web Views of Simulink Models	4-11
About This Tutorial	4-11
Specifying Web View Export Options	4-11
Exporting Models	4-13
Navigating Web Views	4-15
Troubleshooting	4-22
Addressing Web View Display Issues	4-22

Working with Components

5

About Components	5-2
Working with Looping Components	5-3
About Looping Components	5-3
Editing the Figure Loop Tutorial Report Template	5-3
About Figures	5-3
Figure Properties	5-5
Editing Figure Loop Components	5-6

Working with Property Table Components	5-9
About Property Table Components	5-9
Opening the Example Report Template	5-11
Examining the Property Table Output	5-11
Selecting Object Types	5-12
Displaying Property Name/Property Value Pairs	5-12
Editing Table Titles	5-16
Entering Text into Table Cells	5-16
Adding, Replacing, and Deleting Properties in Tables	5-17
Displaying or Hiding Cell Borders	5-18
Adding and Deleting Columns and Rows	5-19
Resizing Columns	5-19
Zooming and Scrolling	5-19
Selecting Tables	5-20
Working with Summary Table Components	5-21
About Summary Table Components	5-21
Opening the Example Report Template	5-23
Selecting Object Types	5-23
Adding and Removing Properties	5-23
Setting Relative Column Widths	5-24
Setting Object Row Options	5-24

Comparing XML Files Exported from Simulink Models

6

How to Compare XML Files Exported from Simulink Models	6-2
Introduction	6-2
Overview of XML Comparison	6-3
Enabling XML Comparison	6-4
Selecting Files to Compare	6-4
Demos of XML Comparison	6-6
See Also	6-7
Using the XML Comparison Report	6-8
Navigating the Simulink XML Comparison Report	6-8
Displaying Items in Original Models	6-10
Understanding the Report	6-12

Saving Comparison Files in a Zip File	6-13
Known Limitations and Workarounds	6-14
Unexpected Results	6-14
Setting File and Memory Sizes	6-15
Comparing XML Files from Models with Identical Names	6-15
Cannot Export XML Text Files from Unsaved Models	6-16
Errors from UNC Paths	6-17
Resolving Cosmetic Issues with the HTML Browser	6-17

Component Reference

7

Real-Time Workshop Components	7-2
Requirements Management Interface Components ...	7-3
Simulink Components	7-4
Simulink Blocks Components	7-7
Simulink® Fixed Point Components	7-8
Stateflow Components	7-9

Components: Alphabetical List

8

Function Reference

9

GUI	9-2
Report Generation	9-3
Web Views	9-4

Functions – Alphabetical List

10

Examples

A

Creating Reports	A-2
Generating Reports from M-files	A-2
Creating Web Views	A-2
Working with Components	A-2

Index

Getting Started

- “Product Overview” on page 1-2
- “What Is the Report Explorer?” on page 1-3
- “Simulink® Report Generator Workflow” on page 1-9
- “How Simulink® Report Generator and Simulink Software Interact” on page 1-10
- “Supported Report Formats” on page 1-11
- “Browser Requirements for Web Views” on page 1-12

Product Overview

The Simulink® Report Generator™ software creates documentation, called *reports*, about Simulink®, Stateflow®, and Real-Time Workshop® data and workflows. It enables you to:

- Create reports for snapshots of models (and their properties) and diagrams.
- Create interactive Web views of models and diagrams.
- Create reports of code generated by the Real-Time Workshop software in Adobe® Acrobat® PDF and Microsoft® Word formats.
- Document results of model simulation.
- Run checks on models using Model Advisor, and report the results.
- Create comparison reports for XML files. See Chapter 6, “Comparing XML Files Exported from Simulink Models”.

What Is the Report Explorer?

In this section...
“About the Report Explorer” on page 1-3
“The Outline Pane” on page 1-5
“The Options Pane” on page 1-6
“The Properties Pane” on page 1-7

About the Report Explorer

The *Report Explorer* is the Simulink Report Generator graphical user interface (GUI). It allows you to:

- Create and modify report templates.
- Apply stylesheets to format the report.
- Specify the report file format.
- Generate reports.

To open the Report Explorer, click **Tools > Report Generator** in the Simulink model window menu bar.

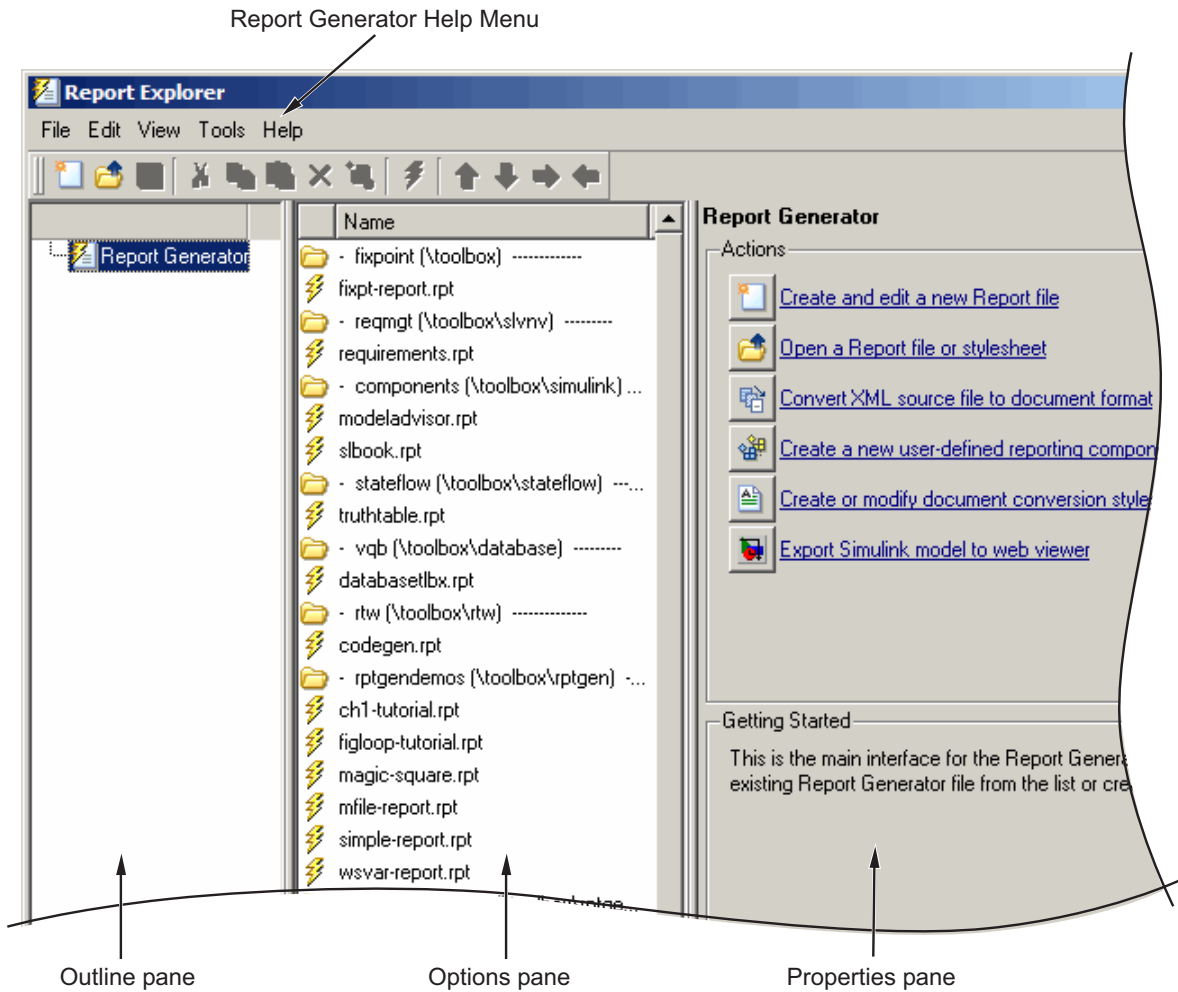

The Report Explorer has three panes:

- The *Outline pane* on the left shows the hierarchy of components in currently opened report templates. Report components can reside within other report components, creating parent, child, and sibling relationships. For more information, see “The Outline Pane” on page 1-5.

- The *Options pane* in the middle lists the options available in the context of the Outline pane. If no report template is open, the Options pane lists available reports. When a report template is open, the Options pane lists components available to insert into it. When a stylesheet is open, the Options pane lists available attributes. For more information, see “The Options Pane” on page 1-6 .
- If no report template is open, the *Properties pane* on the right displays tasks the Report Explorer can perform. If a report template is open, the Properties pane displays the properties of the currently selected item in the Options pane. For more information, see “The Properties Pane” on page 1-7.

Tip If the Report Explorer window opens with only two panes, one of the panes is hidden. You can move the vertical boundaries between the panes to reveal any hidden pane, or to make visible panes wider or narrower.

The Outline Pane

The Outline pane initially includes the top level of the report template.

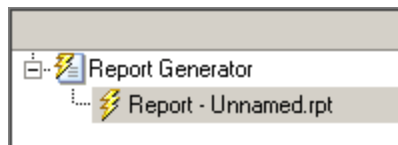

The Options Pane

The Options pane lists by category components that you can add to report templates. In the following figure, the visible component categories are Formatting, Handle Graphics, Logical and Flow Control, and MATLAB. For more information about report components, see Component Reference.

The folder icon represents a component category. The blue square icon represents a component.

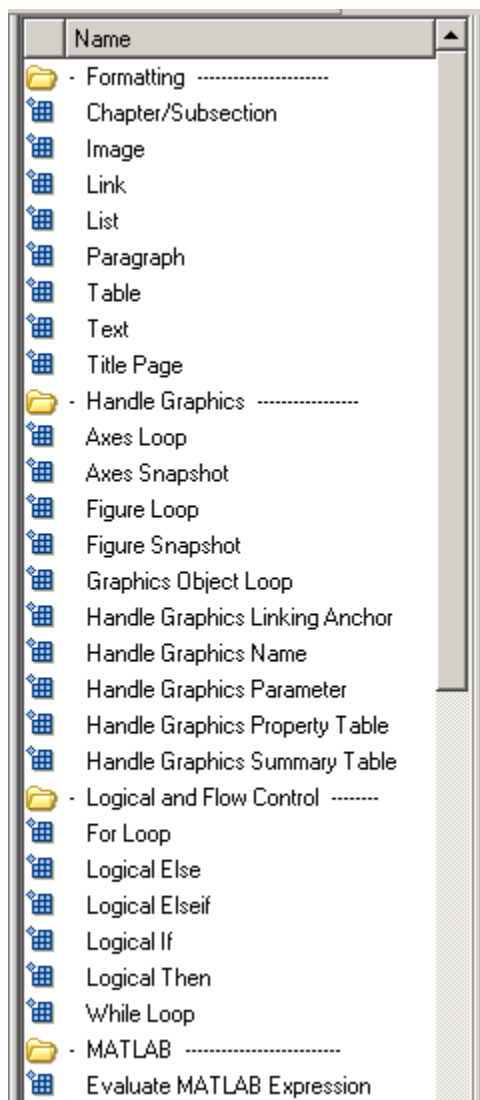

The Properties Pane

After you create a report template, the Properties pane initially shows properties for the report template as a whole.

Report Options

Report File Location

C:\WINNT\Unnamed.htm View...

Directory: Same as setup file ...

Filename: Same as setup file index ...

If report already exists, increment to prevent overwriting

Report Format and Stylesheet

File format: web (HTML) ... Default HTML stylesheet ...

Generation Options

View report after generation

Auto save before generation

Evaluate this string after generation:

Report description:

A report

Simulink Report Generator Workflow

- 1 Open the Report Explorer. In the menu bar on the Simulink model window, click **Tools > Report Generator**.
- 2 Create a new report template. For more information about report templates, see *Creating Simulink Reports*.
- 3 Add existing Simulink or Stateflow components to the report template, or create your own custom components. For more information on using components, see *Working with Components*.
- 4 Choose an existing stylesheet or create a custom stylesheet to apply styles and standards to the report template. For more information, see “Creating Custom Stylesheets” in the MATLAB® Report Generator™ documentation.
- 5 Generate the report.

The following figure illustrates a typical Simulink Report Generator workflow.

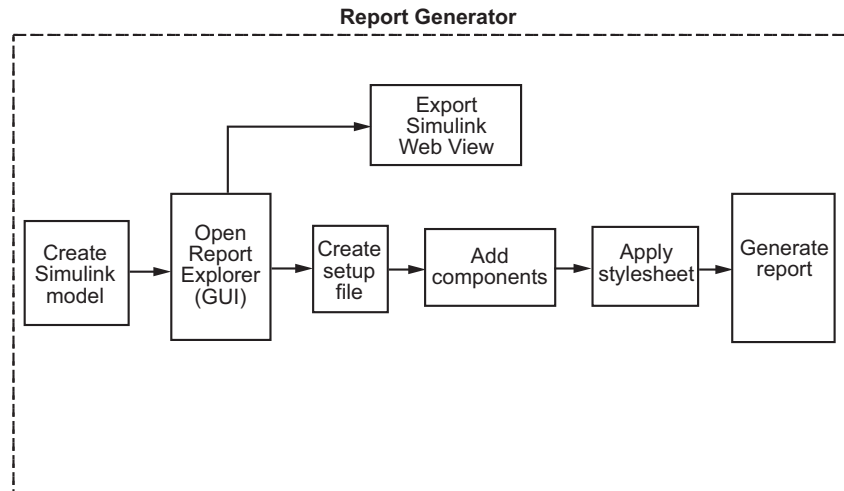

How Simulink Report Generator and Simulink Software Interact

The Simulink and Simulink Report Generator software interact to create reports and Web views. The following table describes these interactions.

User Interface	Interaction with Simulink Report Generator software	Description
Report Explorer	The Report Explorer is the Simulink Report Generator graphical user interface (GUI). For more information, see “What Is the Report Explorer?” on page 1-3.	Use the Report Explorer to edit existing report templates, components, stylesheets, and attributes, or to customize your own.
Simulink model window	Use Simulink model windows to: <ul style="list-style-type: none"> • Export the model to a Web view without using the Report Explorer • Start the Report Explorer to export the model to a Web view or generate a report 	Use the Simulink model window to: <ul style="list-style-type: none"> • Create a report that incorporates the current Simulink model • Export the model to a Web view For more information, see Exporting Simulink Models to Web Views.

Simulink Report Generator software also interacts with Real-Time Workshop and Stateflow software.

Use report generation capabilities with the Real-Time Workshop software to:

- Create Adobe Acrobat PDF and Microsoft Word documents for generated code.

Use report generation capabilities with the Stateflow software to:

- Take snapshots of charts.
- Describe truth tables.
- Document chart hierarchy.
- Document object properties.

Supported Report Formats

When the report generation process first creates a report, it generates a DocBook XML source file. You can customize this XML as needed. For more information, see the OASIS DocBook TC Web page at <http://www.oasis-open.org>.

Next, the report generation process converts the XML source to one of these user-specified report formats:

- Rich Text Format (RTF)
- Hypertext Markup Language (HTML)
- Microsoft Word (.doc)
- Adobe Acrobat PDF

Note Only PDF reports support .bmp and .jpg images.

Browser Requirements for Web Views

Web views require a Web browser that supports Scalable Vector Graphics (SVG). Web views use SVG to render and navigate models.

The MathWorks recommends the following Web browsers:

- Mozilla Firefox Version 1.5 or later, which has native support for SVG. To download the Firefox browser, see <http://www.mozilla.com/>.

Note Firefox for Mac OS® platforms does not currently support Web views.

- The Microsoft Internet Explorer® Web browser with the Adobe® SVG Viewer plug-in. To download the Adobe SVG Viewer plug-in, see <http://www.adobe.com/svg/>.

Creating Simulink Reports

- “About This Tutorial” on page 2-2
- “Setting Report Options in the Report Template” on page 2-3
- “Adding Components to the Report Template” on page 2-5
- “Generating the Report” on page 2-49

About This Tutorial

This tutorial demonstrates the following tasks:

- Inserting models and scopes into reports
- Creating tables in reports using workspace data
- Evaluating MATLAB® expressions
- Inserting values of workspace variables into reports
- Creating reports with chapters and subsections
- Running loops and flow control
- Handling errors

It shows you how to use the Report Explorer to design a report template and generate a report that does the following:

- Opens a Simulink model for the van der Pol equation, called the `vdp_model`.
- Sets the `Gain` parameter for the `Mu` block to five different values.
- Simulates the model each time the `Gain` parameter is set.
- Collects the results. Results that fall within a specified range appear in a table in the generated report.

You do not need to know MATLAB or Simulink software to run this tutorial. However, knowledge of these products might be helpful for understanding the M-code and model simulation that executes.

Setting Report Options in the Report Template

To create and configure the report template:

- 1 Start a Simulink software session.
- 2 Open the Report Explorer by clicking **Tools > Report Generator** in the Simulink model window menu bar.
- 3 Select **File > New** to create a report template.
- 4 Save the report template.

In the Properties pane:

- a Specify where to save the report template. To save it in the current working directory, select Present Working Directory from the **Directory** selection list.
- b Specify the report format. In the **File format** selection list, select Acrobat (PDF).
- c Enter a description for the report. In the **Report description** text box, replace the existing contents with the following text.

Tip Copy and paste this code from the HTML documentation into the Report Explorer.

Simulink Dynamic Report

This report opens up a model, sets a block parameter several times, simulates the model, and collects the results. Results that fall within a specified range are displayed in a table after the test is complete.

The report is configured to test the vdp model only.

By selecting the Eval String component immediately below the Report component, you can modify

```
* model  
* block
```

- * parameter
- * tested values

5 Click **File > Save As** to save the report template as `simulink_tutorial.rpt`.

The Outline pane on the left displays the new file name.

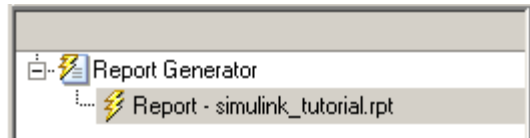

Adding Components to the Report Template

In this section...
“What Are Components?” on page 2-5
“Adding MATLAB Code” on page 2-7
“Adding a Title Page” on page 2-13
“Opening the Simulink Model” on page 2-16
“Adding Logical Then and Logical Else Components” on page 2-18
“Displaying an Error When the Model Cannot Be Opened” on page 2-19
“Creating the Body of the Report” on page 2-22

What Are Components?

Report *components* specify what information to include in the report. The following figure shows a sample page from the report you create in this tutorial, and which components you use to produce this output.

Note Report components added to the report template must not be deactivated in order for the report to generate correctly.

Chapter/
Subsection
component → **Chapter 1. Model - vdp**

Paragraph
component → This report demonstrates Report Generator's ability to experiment with Simulink systems and auto-document the results. In this report, you load the model vdp and simulate it length times. This report modifies the vdp/Mu block's "Gain" value, setting it to the values [-1 0 0.5 1 2]. Each iteration of the test includes a set of scope snapshots in the report.

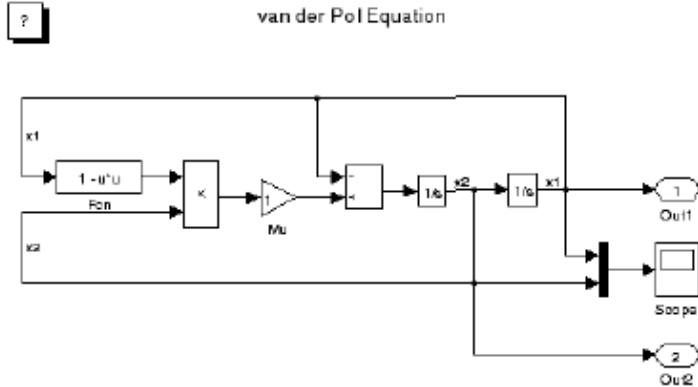

System
Snapshot
component →

Chapter/
Subsection
component → **Processing the vdp model**

Insert
Variable
component → *Iteration_Value - 1*

Figure 1.1. Scope

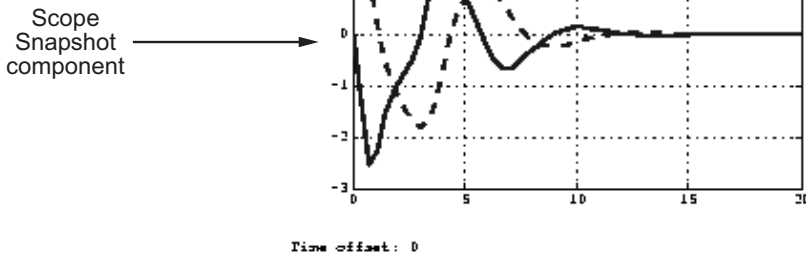

Adding MATLAB Code

The first component to add is the Evaluate MATLAB Expression component, which evaluates MATLAB commands in the workspace. The code in this component assigns initial values to variables used in this tutorial.

- 1 In the Outline pane on the left, select `simulink_tutorial.rpt`.

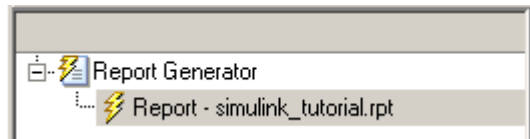

- 2 In the Options pane in the middle, under the MATLAB category, select Evaluate MATLAB Expression.

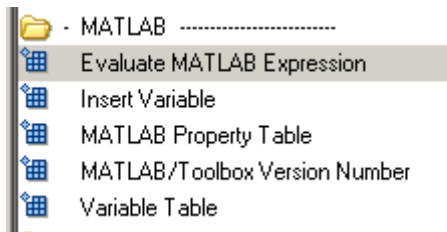

- 3 In the Properties pane on the right, click the icon next to **Add component to current report** to insert the component into the report.

Note You cannot edit the component information in the Properties pane on the right until you add the component to the report.

In the Outline pane on the left, the Evaluate MATLAB Expression component appears under the `simulink_tutorial` report template. The Simulink Report Generator software abbreviates the component name to `Eval`.

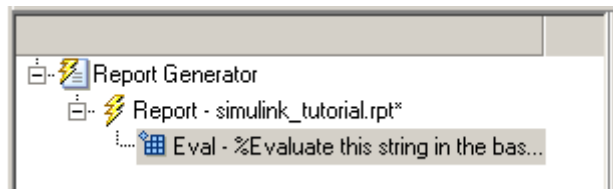

The icon in the upper-left corner of the Eval component's icon indicates that this component cannot have child components. By default, any components you add while the Eval component is selected are siblings of this component.

The options for the Evaluate MATLAB Expression component appear in the Properties pane on the right.

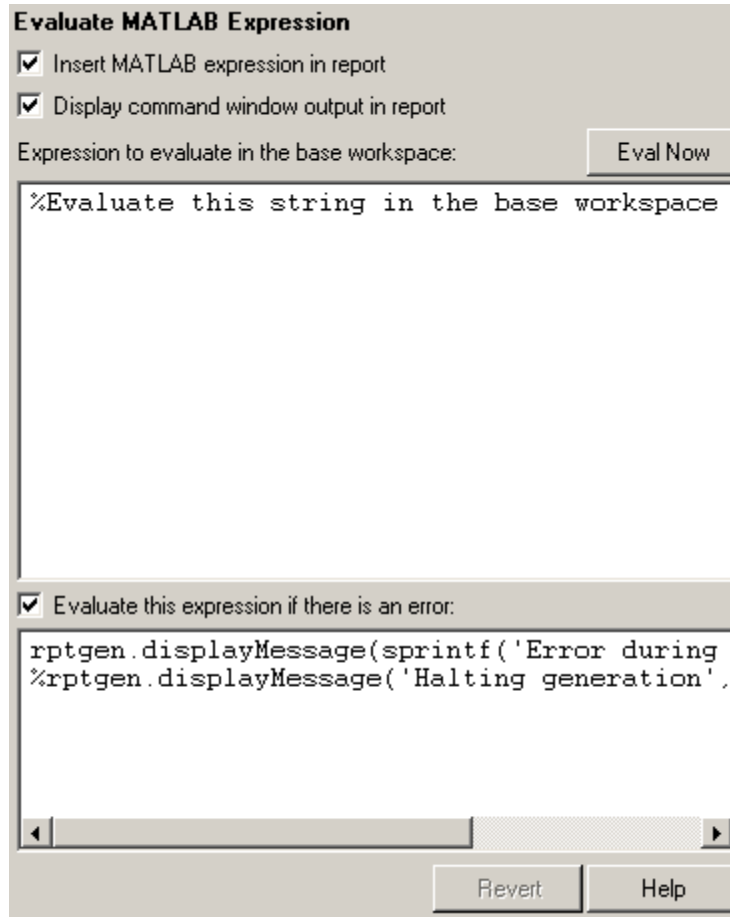

- 4** Clear the **Insert MATLAB expression in report** and the **Display command window output in report** check boxes so you do not include MATLAB code or output in this report.
- 5** Add M-code to the **Expression to evaluate in the base workspace** text box to specify the following values:
 - The model name
 - The block name
 - The block parameter

- Parameter values
- Other initial values required for processing the vdp model

Replace the existing text with the following M-code.

```
%The name of the model
%that will be changed
expModel='vdp';

%The name of the block in the model
%that will be changed
expBlock='vdp/Mu';

%The name of the block parameter
%that will be changed
expParam='Gain';

%The values that will be set
%during experimentation
expValue=[-1 0 .5 1 2];

%expValue can be either a vector
%or a cell array

testMin=2.1;
testMax=3;

%---- do not change code below line ----

try
    open_system(expModel);
end

expOkValues=cell(0,2);
```

Note When you change a field in the Properties pane on the right, the field background changes color (the default is a cream color), indicating that there are unapplied changes to that field. As soon as you perform operations on another component, the Simulink Report Generator software applies the changes, and the background color becomes white again.

- 6** Select the **Evaluate this expression if there is an error** check box.
- 7** In the field under the check box, replace the existing text with the following text:

```
disp(['Error during eval: ', lasterr])
```

The Report Explorer window now looks as follows.

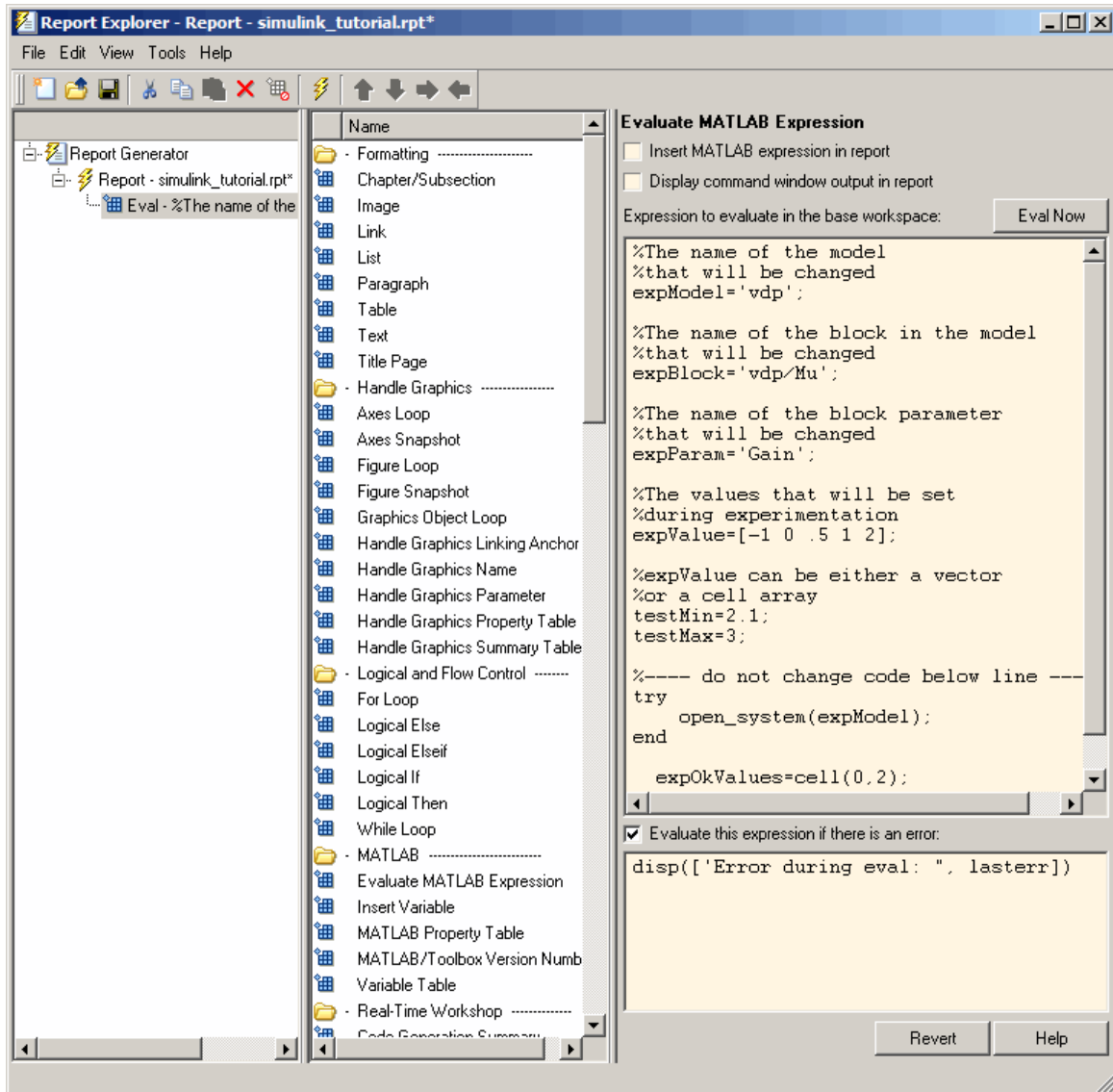

Tip To run the commands that you specified in your MATLAB expression, click the **Eval Now** button. This button is located at the upper-right corner of the Report Explorer. This is an easy way to ensure that your commands are correct and will not cause report generation problems.

8 Click **File > Save** to save the report template.

Adding a Title Page

Create a custom title page for your report using the **Title Page** component.

1 In the Outline pane on the left, select the **Eval** component.

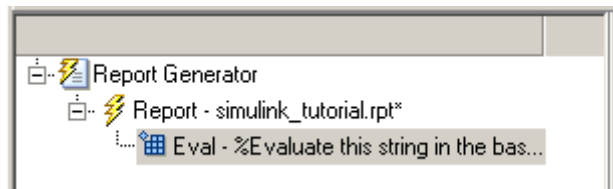

2 In the Options pane in the middle, under the **Formatting** category, click **Title Page**.

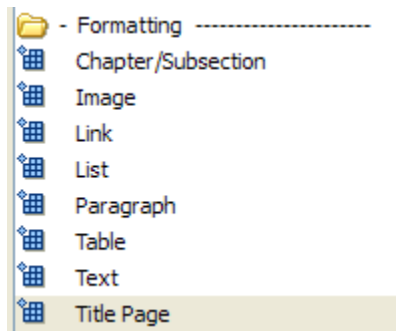

3 Click the icon next to **Add component to current report**.

The **Title Page** component appears in the Outline pane.

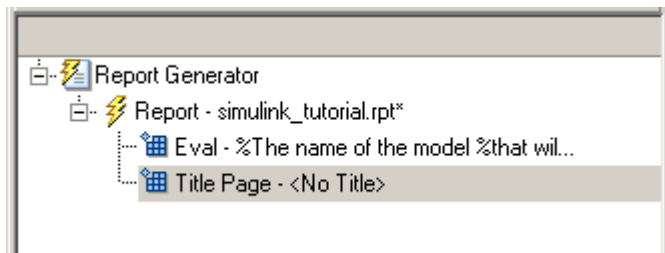

- 4** In the Properties pane on the right:
 - a** In the **Title** text box, enter:

Dynamic Simulink Report
 - b** In the **Subtitle** text box, enter:

Using Simulink Report Generator to Document Changes
 - c** In the **Options** section, choose Custom Author from the selection list.
 - d** Enter your name in the text box.
 - e** Select the **Include report creation date** check box.
 - f** Select the default date and time format from the selection list. The Properties pane on the right looks as follows.

Title Page

Title

Title:

Subtitle:

Options

Image file name:

Custom author:

Include report creation date:

Include copyright holder and year:

Abstract

Legal notice

5 Save the report template.

Opening the Simulink Model

The following statement in the Evaluate MATLAB Expression component that you created in “Adding MATLAB Code” on page 2-7 tries to open the vdp model:

```
try
    open_system(expModel);
end
```

Tip Select the Eval component in the Outline pane on the left to look at this code again.

To see if the vdp model was successfully opened, test the result of the `open_system` command using a Logical If component.

- 1 In the Outline pane on the left, select the Title Page component.
- 2 In the Options pane in the middle, under the Logical and Flow Control category, select Logical If. This component checks to see if a given condition is true or false; in this case, if the model opened successfully.

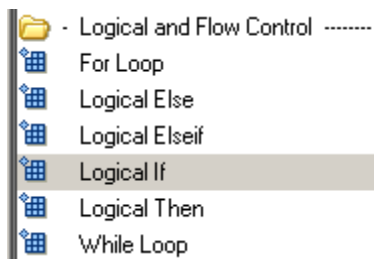

- 3 In the Properties pane on the right, click the icon next to **Add component to current report**. The Logical If component appears as if in the Outline pane.

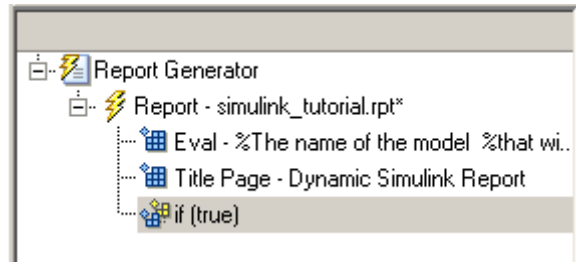

These components are child components of the report and siblings of one another. Components can have parent, child, and sibling relationships.

This component can have child components. “Adding Logical Then and Logical Else Components” on page 2-18 explains how to add two child components to the if component.

- 4 In the Properties pane on the right, in the **Test expression** text box, replace the default text, true, with the following text:

```
strcmp(bdroot(gcs),expModel)
```

The if component name in the Outline pane changes to include this expression.

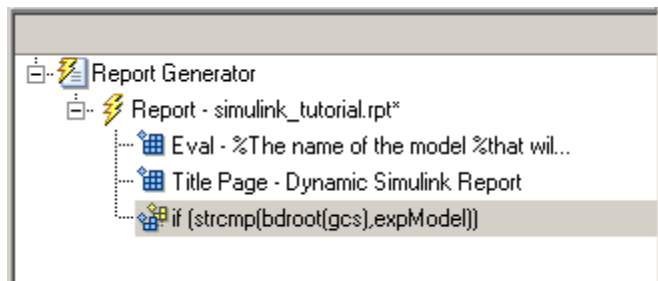

The strcmp function compares the name of the open Simulink model and the value of expModel, which was set to 'vdp'. It tests to see if the vdp model opened successfully. strcmp returns 1 (true) if the two strings match, and 0 (false) if not.

- 5 Save the report template.

Adding Logical Then and Logical Else Components

The `if strcmp(bdroot(gcs), expModel)` component has two possible results. Add two child components to the report template to process these cases.

- 1 In the Outline pane on the left, select the `if` component.

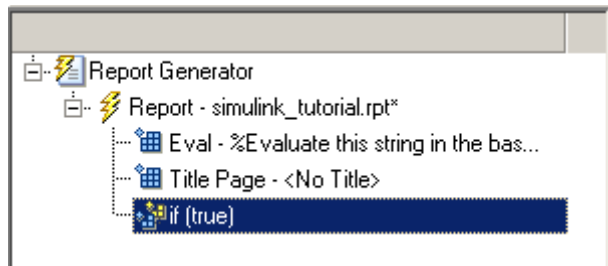

- 2 In the Options pane in the middle, under the Logical and Flow Control category, double-click Logical Then.
- 3 In the Outline pane on the left, select the `if` component again.
- 4 In the Options pane in the middle, under the Logical and Flow Control category, double-click Logical Else.

Both elements are added as child components to the `if` component, as shown in the Outline pane.

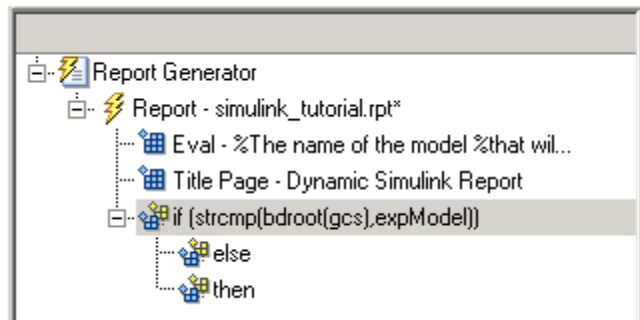

- 5 To move the else component under the then component, select the else component and click the **down** arrow on the toolbar once. The Outline pane on the left looks as follows.

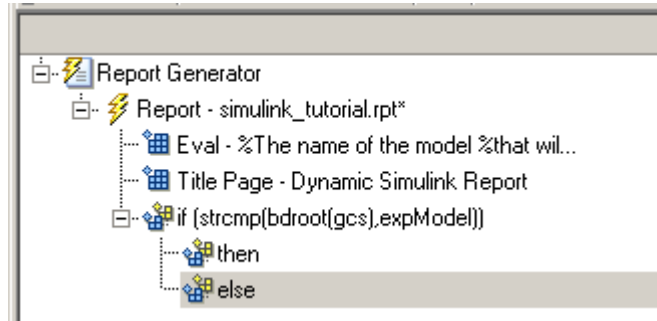

- 6 Save the report template.

Displaying an Error When the Model Cannot Be Opened

If the `if strcmp(bdroot(gcs), expModel)` component fails (the vdp model cannot open), the `else` component executes. Display an error message in the report using the Chapter/Subsection component.

- 1 In the Outline pane on the left, select the `else` component.

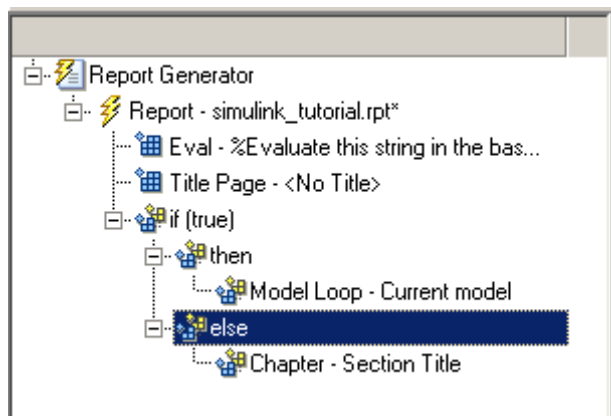

- 2 In the Options pane in the middle, under the Formatting category, double-click Chapter/Subsection to add it as a child of the else component. This component displays an error message if an error occurs when opening the vdp model.

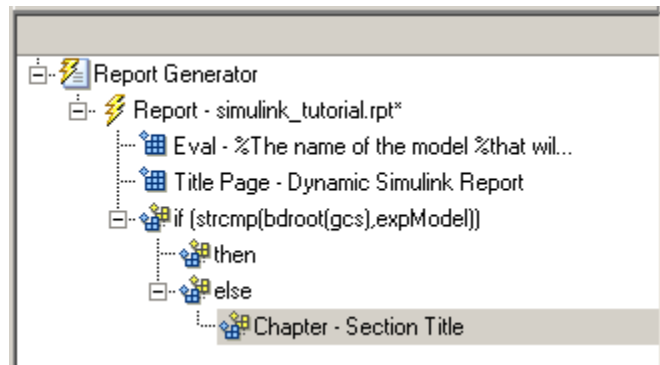

Note When you add a component to a report, it is added by default as a child component unless the selected component cannot have child components.

- 3 In the Properties pane on the right, choose Custom from the **Title** selection list, and then enter the following text in the text box:

Load Model Failed.

The Outline pane looks as follows.

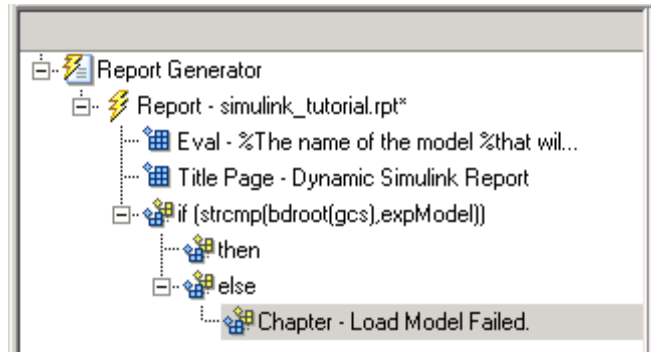

- 4 In the Outline pane on the left, select the Chapter component.
- 5 In the Options pane in the middle, under Formatting, double-click Paragraph.
- 6 In the Properties pane on the right, enter the following text in the **Paragraph Text** text box to display the following error message:

Error: Model %<expModel> could not be opened.

The expression %<expModel> indicates that the value of the workspace variable expModel is inserted into the text, as in the following example.

Error: Model vdp could not be opened.

The Outline pane on the left looks as follows.

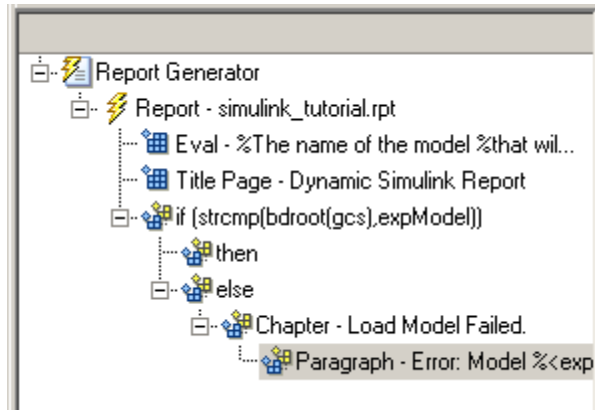

7 Save the report template.

Creating the Body of the Report

The report generation process performs several tasks to successfully open the vdp model. Each action requires a separate component under the then component.

Processing the Model with a Model Loop Component

The report changes the Gain parameter for the Mu block in the vdp model several times. This task requires a Model Loop component.

- 1 In the Outline pane on the left, select the then component.
- 2 In the Options pane in the middle, scroll down to the Simulink category, and then double-click Model Loop. It is added as a child of the then component.

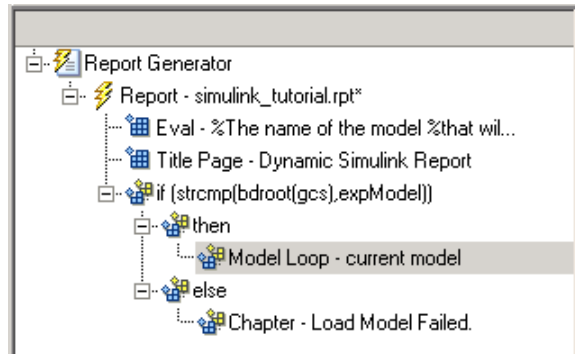

The Properties pane on the right looks as follows.

Model Loop

Models to Include

Models to Include:

Current block diagram

Model Options

Active

Model name: Current block diagram

Traverse model: All systems in model

Look under masks: Functional masks only

Follow library links: Do not follow library links

Starting system(s): Model root

Section Options

Create section for each object in loop

Display the object type in the section title

Create link anchor for each object in loop

Revert Help

- 3 In the Properties pane on the right:
 - a Select the **Active** check box to process the vdp model.
 - b In the **Traverse model** selection list, select **Selected system(s) only** to traverse only the vdp model.
 - c Select **Model root** from the **Starting system(s)** selection list.
 - d At the bottom of the Properties pane on the right, select the **Create section for each object in loop** check box to create a chapter or section for each model. When you select this check box, the component name in the Outline pane on the left changes to **Model Loop Chapter**.

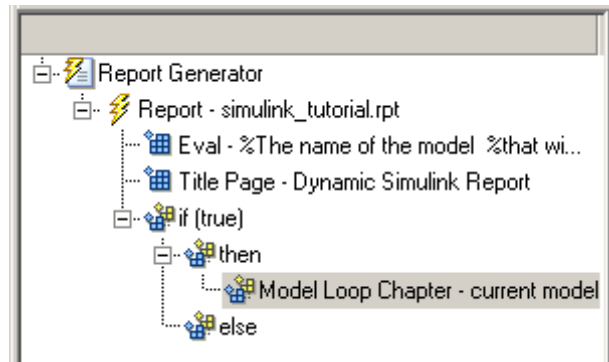

- e Select the **Display the object type in the section title** check box to include the object type (in this example, model) in the title name.
 - f Clear the **Create link anchor for each object in loop** check box.
- 4 Save the report template.

Adding a Paragraph for Each Model

In each Model Loop Chapter, add an explanation using the Paragraph component.

- 1 In the Outline pane on the left, select the **Model Loop Chapter** component.
- 2 In the Options pane in the middle, scroll up to the **Formatting** category, and then double-click **Paragraph**. The **Paragraph** component is added as a child of the **Model Loop Chapter** component.

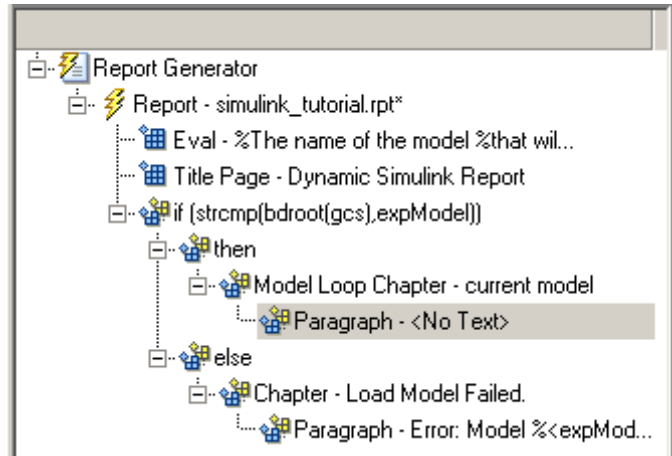

- 3 In the Properties pane on the right, in the **Paragraph Text** text box, enter the following text:

This report demonstrates Simulink Report Generator's ability to experiment with Simulink systems and auto-document the results. In this report, you load the model %<expModel> and simulate it %<length> times. This report modifies the %<expBlock> block's "%<expParam>" value, setting it to the values %<expValue>. Each iteration of the test includes a set of scope snapshots in the report.

When this report is generated, the variable names preceded by percent signs (%) and enclosed in brackets (<>) are replaced with the values of those variables in the MATLAB workspace.

- 4 Save the report template.

Inserting a Snapshot of the Model into the Report

Inside each Model Loop Chapter component, include a snapshot of the current model using the System Snapshot component.

- 1 In the Outline pane on the left, select the Model Loop Chapter component.
- 2 In the Options pane in the middle, scroll down to the Simulink category, and then double-click the System Snapshot component.

This component inserts an image of the current model into your report. The Properties pane on the right looks as follows.

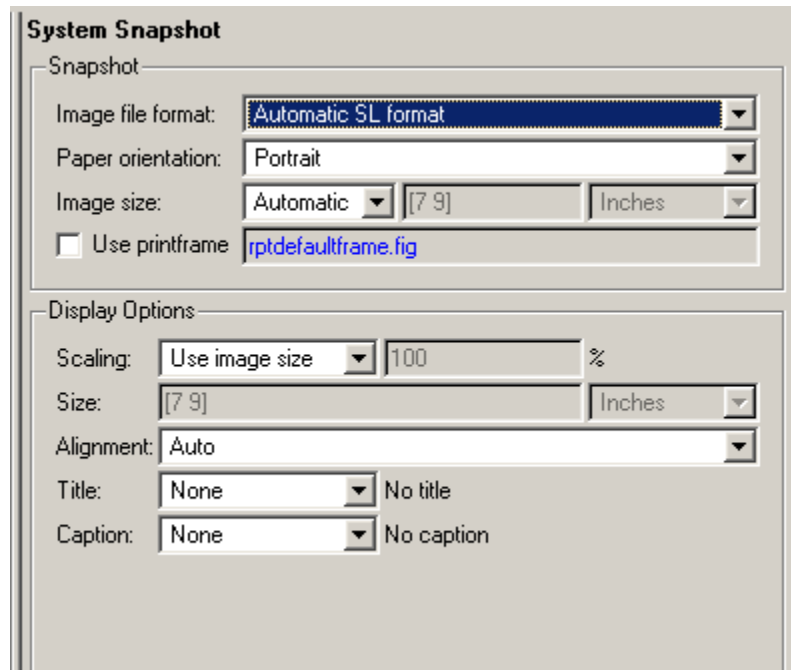

- 3 In the Properties pane on the right:
 - a Select Zoom from the **Scaling** selection list.
 - b Enter 70 as the % value.
- 4 In the Outline pane on the left, select the System Snapshot component.
- 5 Click the **down** arrow on the toolbar once to move it under the Paragraph component.

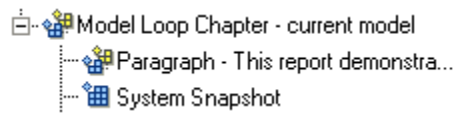

- 6 Save the report template.

Adding a Loop for Processing the Model

Create a loop to process the model %length times using the For Loop component.

- 1 In the Outline pane on the left, select the System Snapshot component.
- 2 In the Options pane in the middle, under the Logical and Flow Control category, double-click For Loop. The For Loop component is added as a sibling of the System Snapshot component.

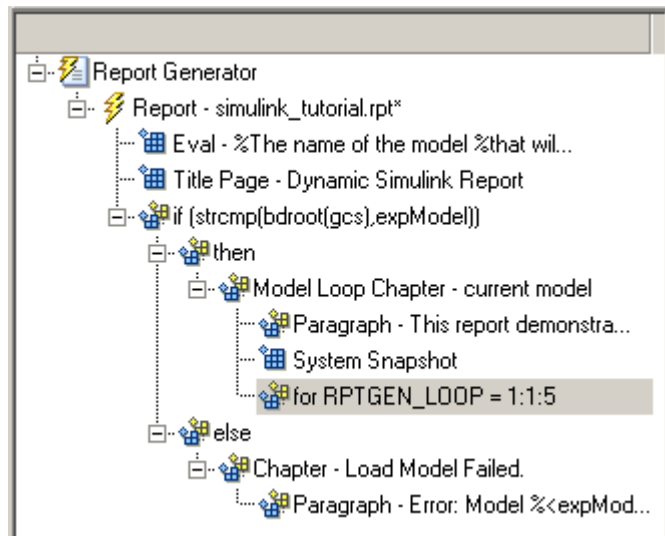

- 3 In the Properties pane on the right:
 - a In the **End** text box, replace the existing text with the following text:

```
length(expValue)
```

expValue is the array of Gain parameter values assigned in the Eval component with the command `expValue=[-1 0 0.5 1 2];`. The expression `length(expValue)` evaluates to 5 in this example.

- b In the **Variable name** text box, replace the existing text with the name of the for loop variable. Enter the following text:

```
expIteration
```

The name of the For component in the Outline pane on the left changes to reflect the loop variable and the termination value.

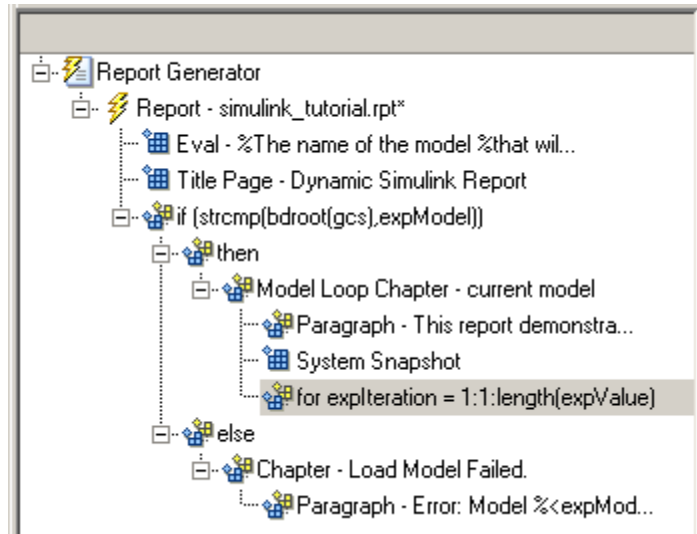

4 Save the report template.

Getting the Gain Parameter Value from the expValue Array

For each iteration, get a value from the expValue array to use as the Gain parameter value. This task requires an Evaluate MATLAB Expression component.

- 1 In the Outline pane on the left, select the for component.
- 2 In the Options pane in the middle, under the MATLAB category, double-click Evaluate MATLAB Expression. In the Outline pane, the component name is shortened to Eval.

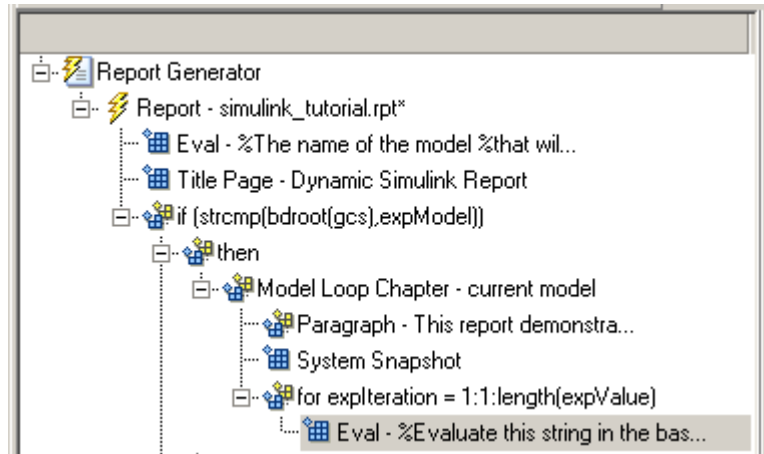

- 3 On the Properties pane on the right:
 - a Clear the **Insert MATLAB expression in report** and **Display command window output in report** check boxes.
 - b Enter the following text in the **Expression to evaluate in the base workspace** text box:

```
%Evaluate this string in the base workspace

if iscell(expValue)
    Iteration_Value=expValue{expIteration};
else
    Iteration_Value=...
        num2str(expValue(expIteration));
end
```

The `Iteration_Value` variable represents the designated array element.

- c Clear the **Evaluate expression if there is an error** check box.
- 4 Save the report template.

Creating a Section for Each Iteration

Create a separate section for each iteration of the loop that includes the data using the Chapter/Subsection component.

- 1 In the Outline pane on the left, select the Eval component.
- 2 In the Options pane in the middle, under the Formatting category, double-click the Chapter/Subsection component to add it as a sibling. This component is automatically added as Section 1 because it is inside a Chapter component (the Model Loop Chapter component).

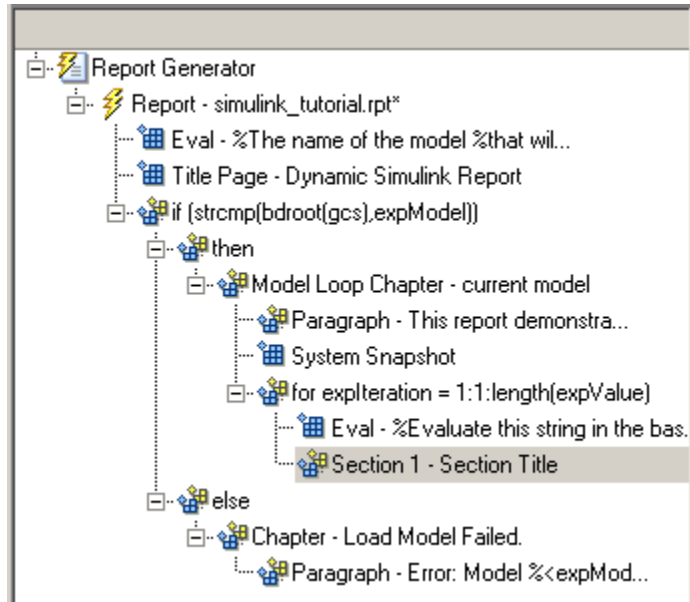

- 3 In the Properties pane on the right:
 - a In the **Title** selection list, select Custom.
 - b In the text box, enter the following title:

Processing the vdp model

This indicates that the section title comes from the first child component. Do not change any other properties.

- 4 Save the report template.

Inserting the Gain Value into the Report

Insert the Gain value that is used for each simulation.

- 1** In the Outline pane on the left, select the Section 1 component.
- 2** In the Options pane in the middle, under the MATLAB category, double-click Insert Variable.
- 3** In the Properties pane on the right:
 - a** In the **Variable name** text box, enter `Iteration_Value`.
 - b** In the **Display as** selection list, select Paragraph.
The Outline pane on the left looks as follows.

Insert Variable

Source

Variable name:

Variable location:

Warning: "Iteration_Value" not found in workspace.

Display Options

Title:

Size limit:

Display as:

Ignore if value is empty

- 4** Save the report template.

Setting the Gain Parameter

For each iteration, set the Gain parameter to the value you extracted from the `expValue` array.

- 1 In the Outline pane on the left, select the **Variable** component.
- 2 In the Options pane in the middle, under the **MATLAB** category, double-click **Evaluate MATLAB Expression**. This component is added as a sibling of the **Variable** component.

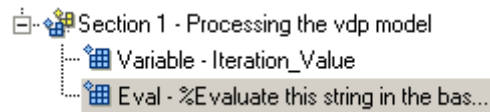

- 3 In the Properties pane on the right, clear the **Insert MATLAB expression in report** and **Display command window output in report** check boxes.
- 4 In the **Expression to evaluate in the base workspace** text box, replace the existing text with the following text.

```
set_param(expBlock,expParam,Iteration_Value);  
okSetValue=(1);
```

The `set_param` command sets the value of the Gain parameter for the Mu block in the vdp model to the value of `Iteration_Value`.

- 5 Make sure you select **Evaluate expression if there is an error**. Enter the following text into the text box:

```
okSetValue=logical(0);
```

If the `set_param` command works, `okSetValue` is set to 1. If an error occurs, `okSetValue` is set to 0. The next component then reports the error and terminates processing.

- 6 Save the report template.

The Outline pane on the left looks as follows.

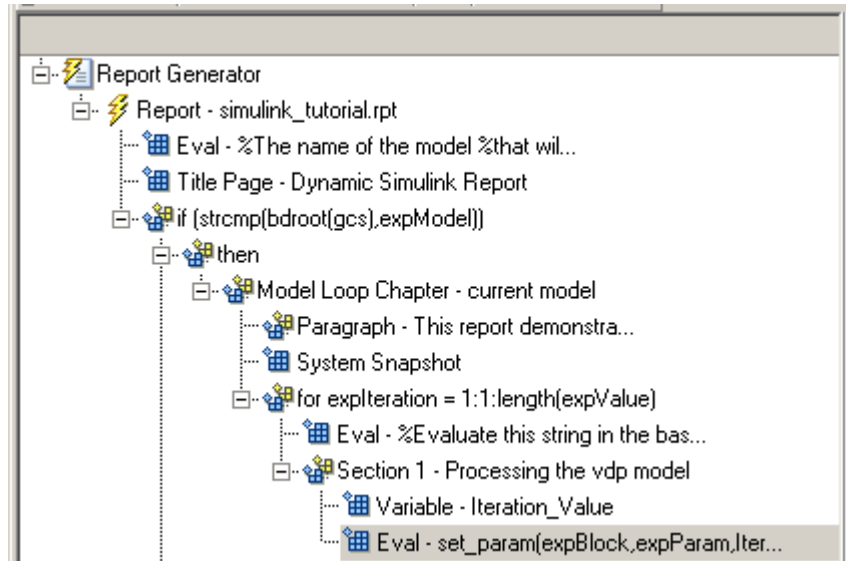

Checking okSetValue

Check the value of `okSetValue` using a Logical If component. If the value is 0, the simulation cannot proceed because the Gain parameter could not be set.

- 1 In the Outline pane on the left, select the Eval component for the `set_param` command.
- 2 In the Options pane in the middle, under the Logical and Flow Control category, double-click Logical If. The component is added as a sibling of Eval.

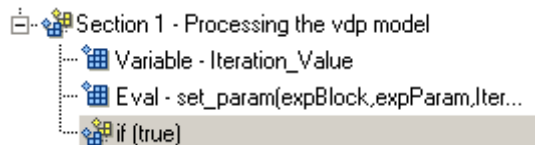

- 3 In the Properties pane on the right, in the **Test expression** text box, replace `true` with `okSetValue`.

okSetValue can be 1 (true) or 0 (false), so insert two components—Logical Then and Logical Else—to process those conditions:

- 1 In the Outline pane on the left, select the `if(okSetValue)` component.
- 2 To insert Logical Then and Logical Else in the correct order:
 - a In the Options pane in the middle, double-click the Logical Else component.
 - b Select the `if(okSetValue)` component again.
 - c Double-click the Logical Then component. The Outline pane on the left looks as follows.

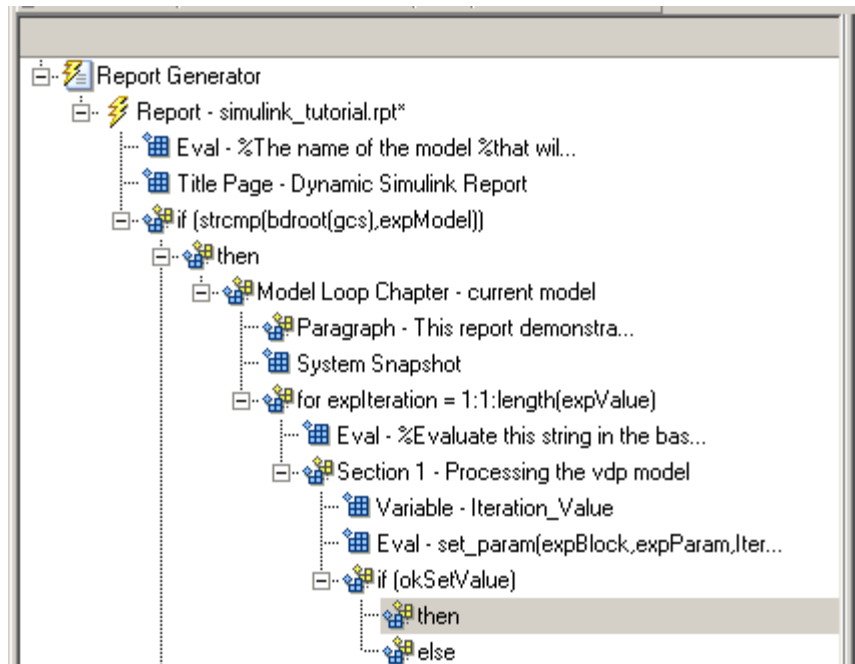

- 3 In the Outline pane on the right, select the `else` component.
- 4 In the Options pane in the middle, double-click Paragraph.

If `okSetValue = 0`, the `Gain` parameter value is not set and the report displays an error.

5 In the Properties pane on the right:

- a** Choose `Custom` title from the **Title Options** selection list.
- b** Enter `Error` in the text box next to the selection list.
- c** Enter the following text into the **Paragraph Text** text box:

```
Could not set %<expBlock> "%<expParam>" to value
%<Iteration_Value>.
```

6 Save the report.

Simulating the Model, and Capturing the Scope and Data

Now that the model is open and the `Gain` parameter is set, use the `Model Simulation` component to simulate the `vdp` model.

- 1** In the Outline pane on the left, select the `then` component under the `if (okSetValue)` component.
- 2** In the Options pane, under the `Simulink` category, double-click `Model Simulation`. In the Outline pane on the left, this component is renamed `Simulate model`.

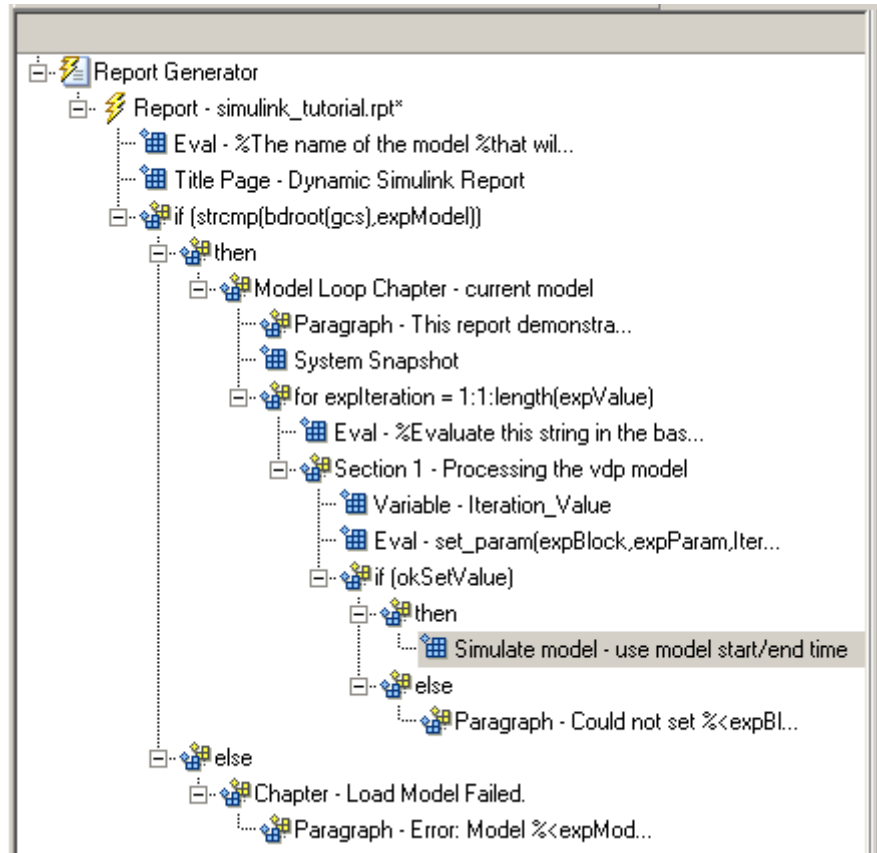

- 3** In the Properties pane on the right:
 - a** Clear the **Use model's workspace I/O variable names** check box.
 - b** In the **Time** text box, enter `dynamicT`.
 - c** In the **States** text box, enter `dynamicX`.
 - d** In the **Output** text box, enter `dynamicY`.The Properties pane on the right looks as follows.

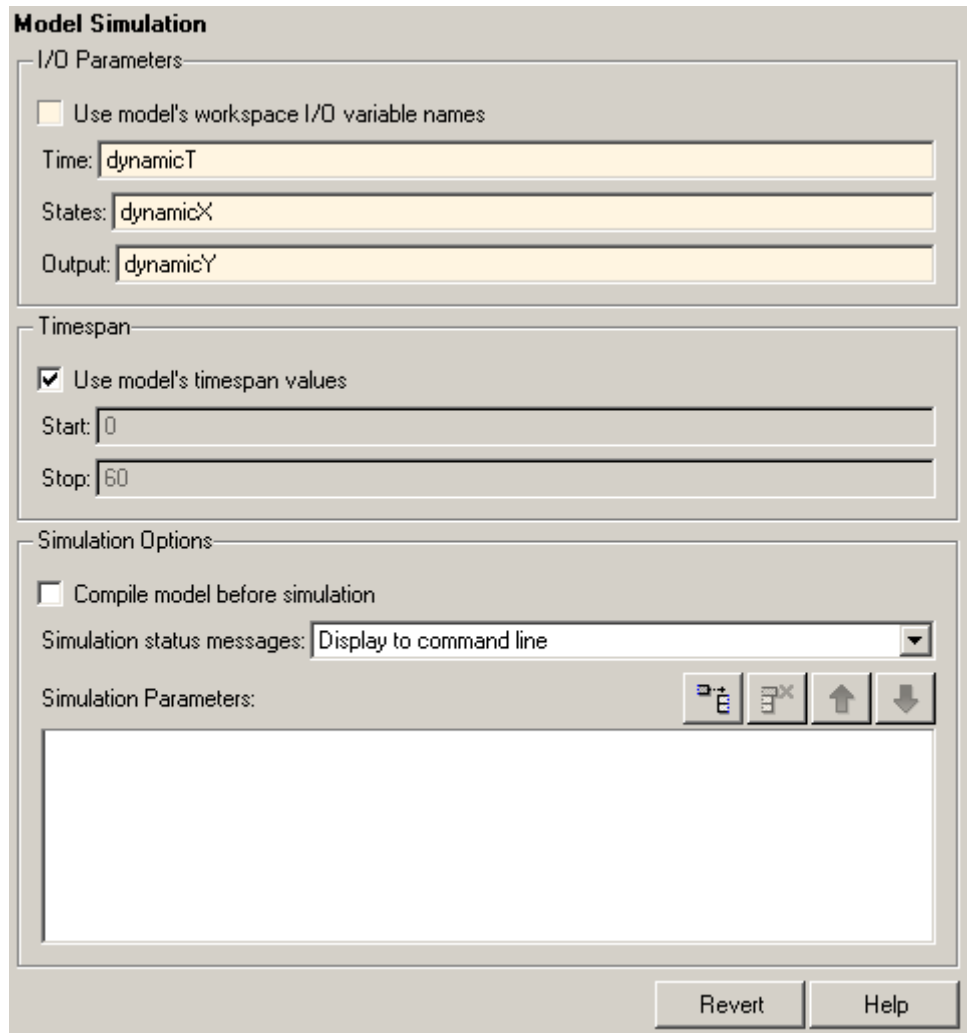

- 4** In the Outline pane on the left, select the `Simulate` model component.
- 5** In the Options pane in the middle:
 - a** Scroll down to the `Simulink Blocks` category.
 - b** Double-click `Scope Snapshot` to add it as a sibling of the `Simulink Model` component.

This component captures the scope for each iteration.

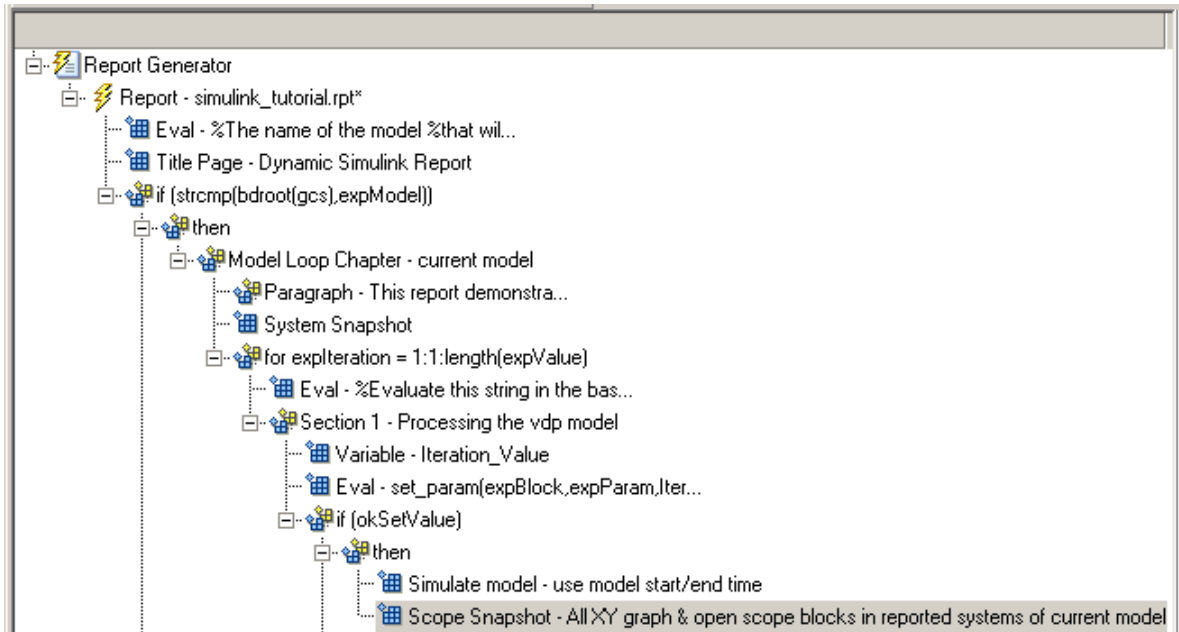

- 6 In the Properties pane on the right:
 - a In the **Paper orientation** selection list, select Portrait.
 - b For the **Image size**, enter [5 4].
 - c In the **Scaling** selection list, select Zoom.
 - d Enter 75 for the % value.
- 7 Save the report template.
- 8 To test to see if the signal data falls within a specified range, add another Logical If component:
 - a In the Outline pane on the left, select the Scope Snapshot component.
 - b In the Options pane in the middle, scroll up to the Logical and Flow Control category.
 - c Double-click the Logical If component.

- 9 To test the signal data, replace true in the **Test expression** text box with the following in the Properties pane on the right:

```
max(dynamicX(:,2))>testMin & max(dynamicX(:,2))
```

- 10 Save the report.

The Outline pane looks as follows:

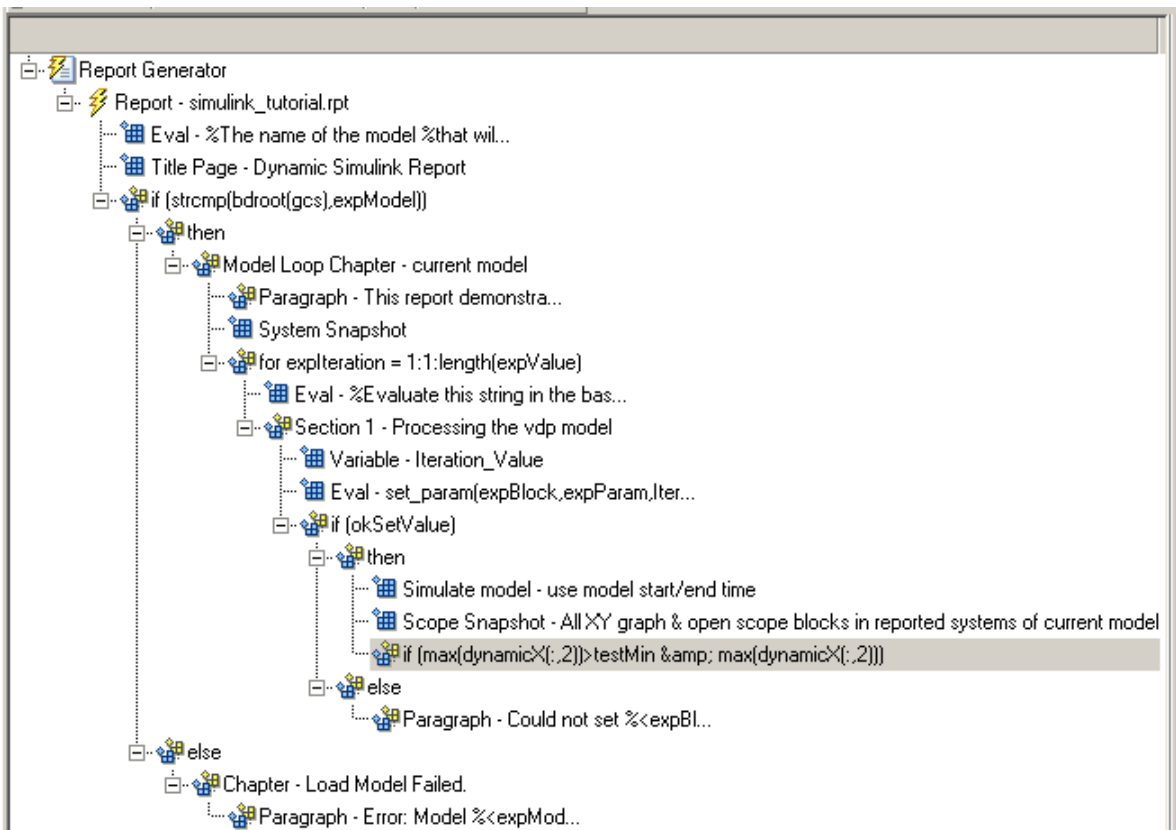

- 11 If this condition is true, the signal data falls within the desired range. Add a Paragraph component to print information about the signal data in the report.
 - a In the Outline pane on the left, select the if component you just added.

- b In the Options pane in the middle, under the Formatting category, double-click Paragraph so that it becomes a child of the if component.

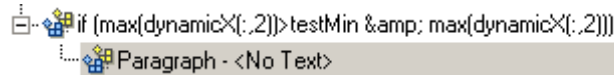

- c In the Properties pane on the right:
 - i From the **Title Options** selection list, select Custom title.
 - ii Type Success in the text box.
 - iii Enter the following text in the **Paragraph text** text box.

The conditioned signal has a maximum value of `%<max(dynamicX(:,2))>`, which lies in the desired range of greater than `%<testMin>` and less than `%<testMax>`.

- 12 To save the success values to insert into a table at the end of the iterations, use an Evaluate MATLAB Expression component.

- a In the Outline pane on the left, select the Paragraph component.
- b In the Options pane in the middle, under the MATLAB category, double-click Evaluate MATLAB Expression.

An unintended result occurs: the new component is a child of the Paragraph component.

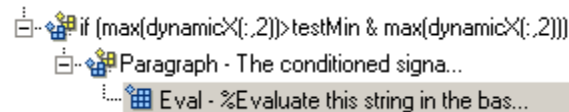

- c To make the new component a *sibling* of the Paragraph component, in the Outline pane on the left, select the Eval component, and then Click the left arrow on the toolbar. The Eval component becomes a sibling of the Paragraph component.

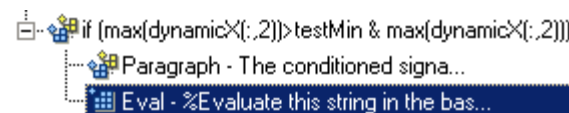

13 In the Properties pane on the right, for the Eval component:

- a** Clear the **Insert MATLAB expression in report** and **Display command window output in report** check boxes.
- b** In the **Expression to evaluate in the base workspace** text box, enter the following to save the desired signal values in the expOkValues array:

```
expOkValues=[expOkValues;...  
             {Iteration_Value,max(dynamicX(:,2))}];
```

- c** Make sure you select **Evaluate this expression if there is an error**. Insert the following text in the text box:

```
disp(['Error during eval: ', lasterr])
```

14 Save the report template.

Creating the Post-Test Analysis Section

Now that you have collected all the desired values, create the post-test analysis section by creating a table and inserting it into your report at the end of this chapter.

- 1** In the Outline pane on the left, select the **Model Loop Chapter** component.

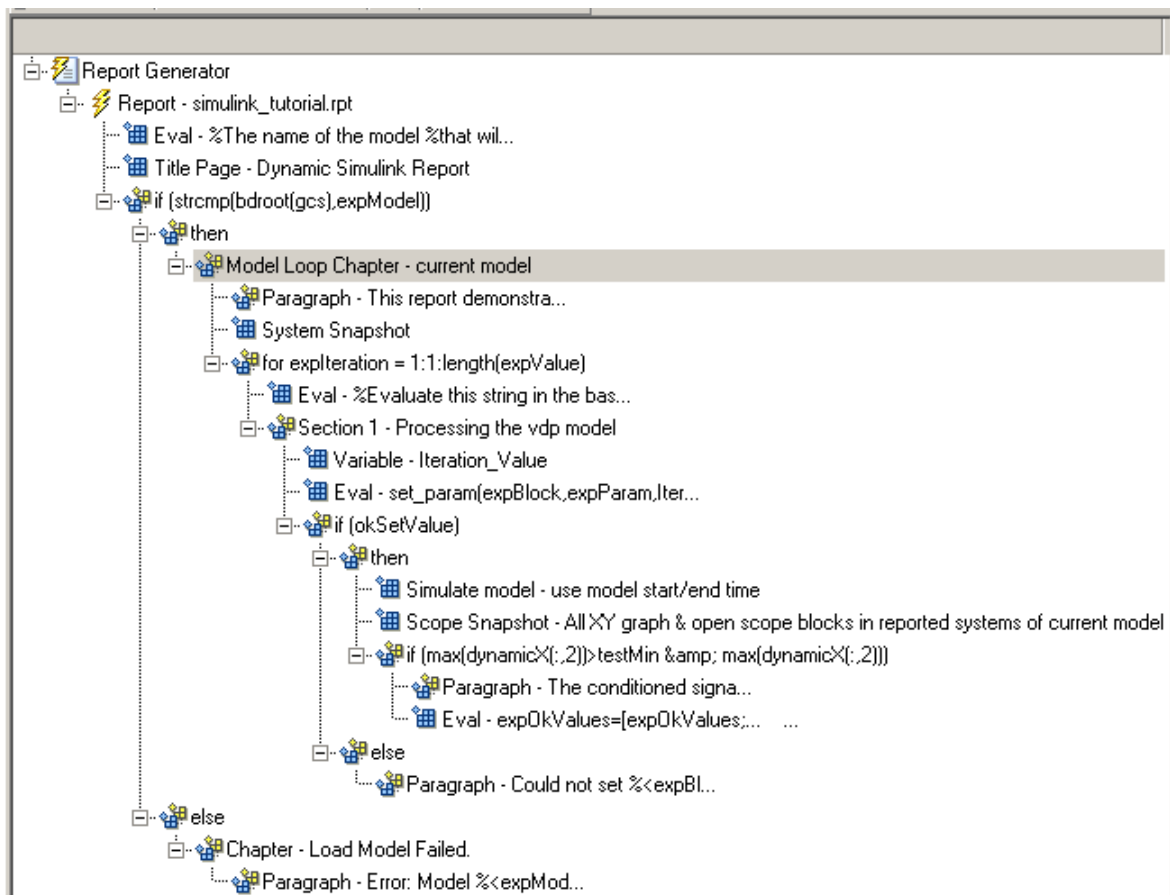

2 In the Options pane in the middle, under the Formatting category, double-click Chapter/Subsection.

The new section appears at the beginning of the chapter.

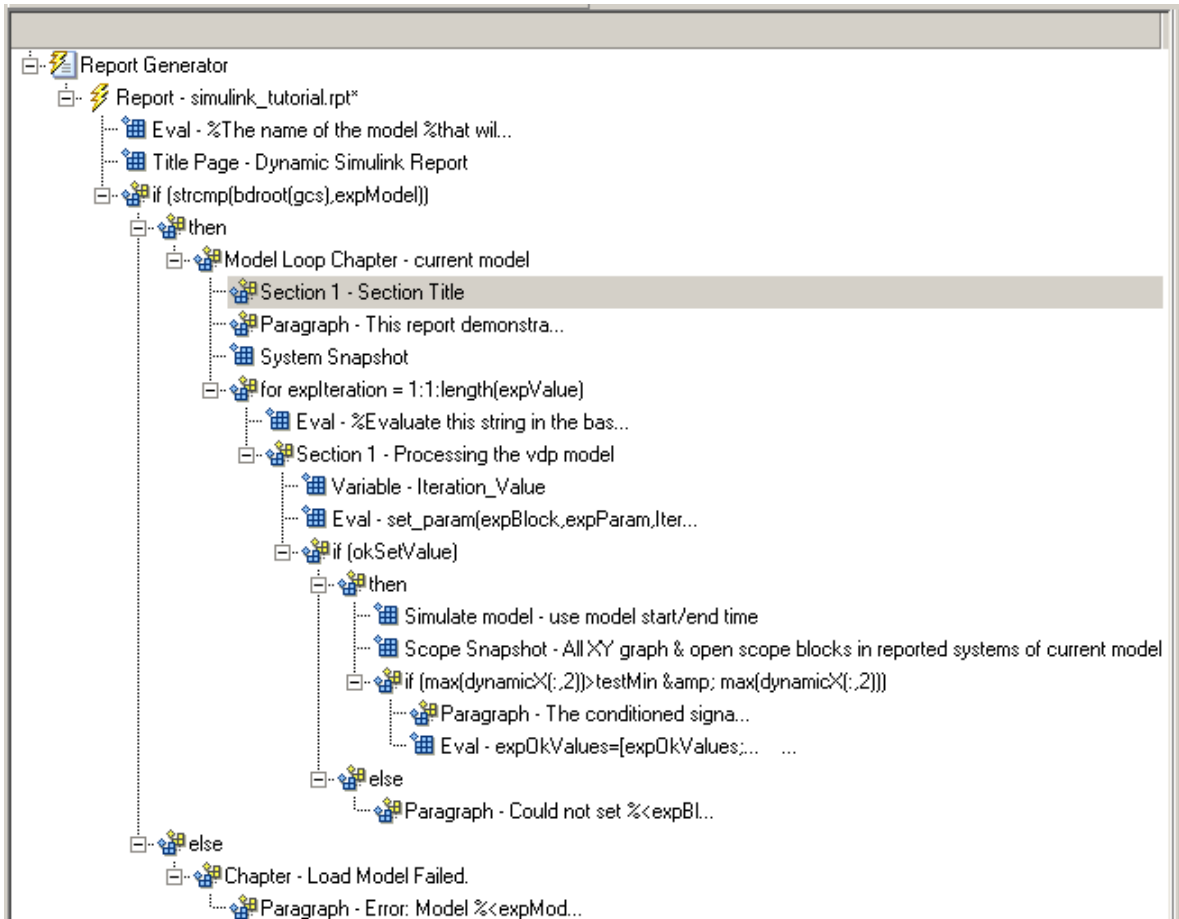

Click the **down** arrow three times so Section 1 moves to the end of the Model Loop Chapter component.

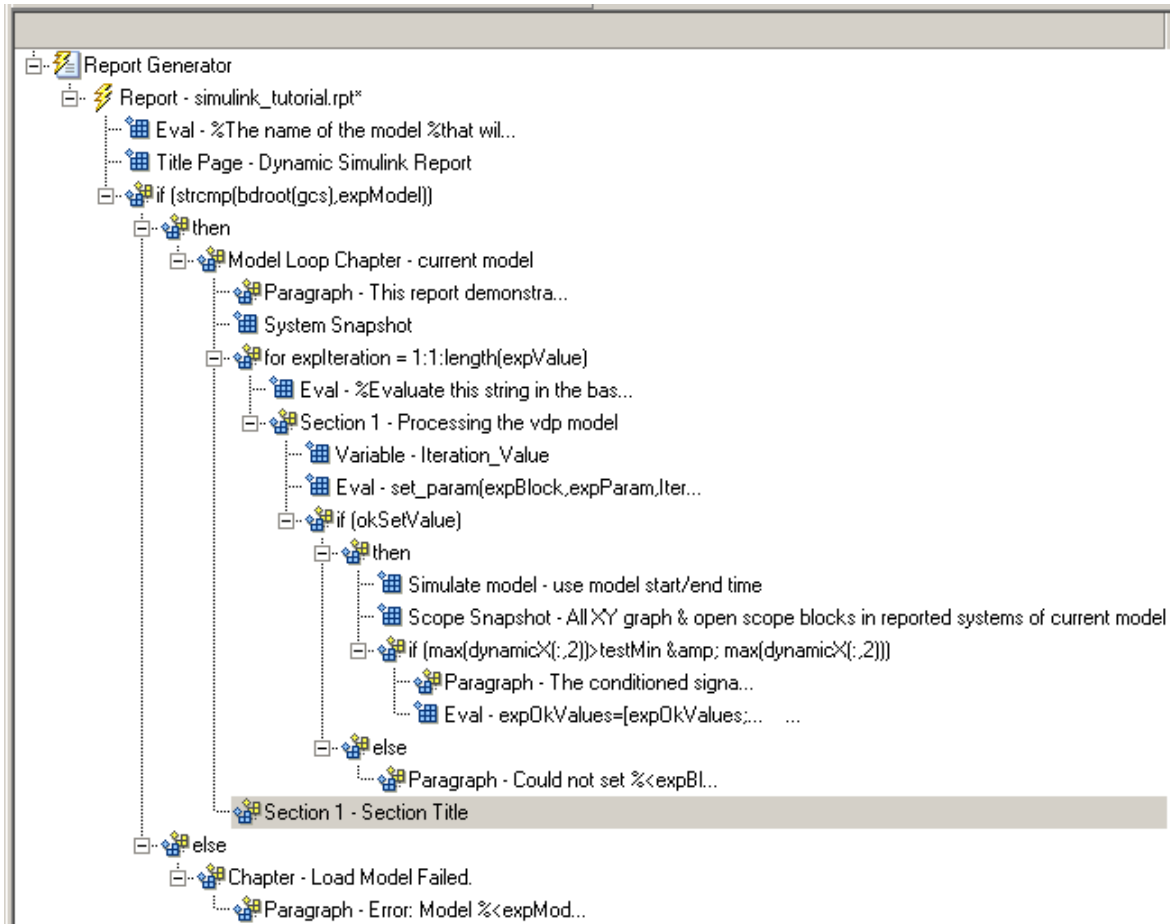

3 In the Properties pane on the right:

- a** Select Custom in the **Title** selection list.
- b** Enter Post-Test Analysis in the text box.

4 In the Outline pane on the left, select the new Section 1 component.

5 In the Options pane in the middle, under the Formatting category, double-click Paragraph. Do not change its properties.

6 To check whether there are any signal values within the desired range, check the array `expOkValues` with a **Logical If** component. If `expOkValues` is empty, there are no signal values in the desired range. Report the result of this check.

- a** In the Outline pane on the left, select the **Paragraph** component and add a **Logical If** child component.
- b** In the Properties pane on the right, enter the expression to evaluate in the **Test expression** text box:

```
~isempty(expOkValues)
```

This expression evaluates to 0 (false) if `expOkValues` is empty; otherwise, it evaluates to 1 (true).

- c** In the Outline pane on the left, select the `if (~isempty(expOkValue))` component and add the **Logical Else** component as a child.
- d** Select the `if (~isempty(expOkValue))` component again and add the **Logical Then** component as a child.

The two components are siblings in the Outline pane on the left.

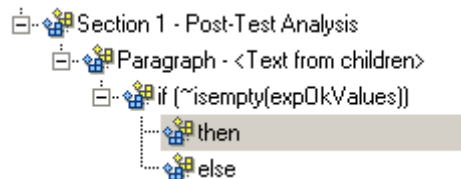

7 Save the report template.

8 Now, insert report components to handle the case where `expOkValues` is empty; that is, where no signal values fall within the designated range.

- a** In the Outline pane on the left, select the **else** component.
- b** In the Options pane in the middle, double-click the **Text** component to add it as a child of the **else** component.
- c** In the Properties pane on the right, in the **Text to include in report** text box, enter the following:

```
None of the selected iteration values had
```

a maximum signal value between %<testMin> and %<testMax>.

- 9 Now handle the case where `expOkValues` is not empty and you want to insert a table of the acceptable signal values.
 - a In the Outline pane on the left, select the `then` component.
 - b Add a Text component as a child to the `then` component.
 - c In the Properties pane on the right, in the **Text to include in report** text box, enter the following text.

```
%<size(expOkValues, 1)> values for %<expBlock> were  
found that resulted in a maximum signal value greater  
than %<testMin> but less than %<testMax>. The following  
table shows those values and their resulting signal maximum.
```

- d In the Outline pane on the left, select the Text component under the `then` component of the `if(~isempty(expOkValues))` component.
- 10 To create an array for use when formatting the table, use the Evaluate MATLAB Expression component.
 - a In the Options pane in the middle, double-click Evaluate MATLAB Expression.
 - b In the Properties pane on the right:

- i Clear the **Insert MATLAB expression in report** and **Display command window output in report** check boxes.
 - ii The next component of the report uses the strings `Mu Value` and `Signal Maximum` as table header values. Add the strings to the front of the `expOkValues` cell array by entering the following text into the **Expression to evaluate in the base workspace** text box:

```
expOkValues=[{'Mu Value','Signal Maximum'} expOkValues];
```

- iii Make sure you select the **Evaluate this expression if there is an error** check box. Enter the following text into the text box:

```
disp(['Error during eval: ', lasterr])
```

- 11 In the Outline pane on the left, select the Eval component.
- 12 In the Options pane in the middle, under the Formatting category, double-click the Table component so it becomes a sibling of the Text and Eval components.

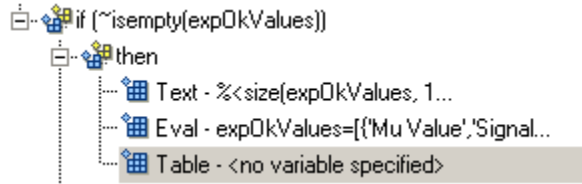

- 13 In the Properties pane on the right:
 - a In the **Workspace variable name** text box, enter `expOkValues`. The Simulink Report Generator software uses the contents of `expOkValues` to construct the table.
 - b In the **Table title** text box, enter `Valid Iteration Values`.
- 14 Save the report template.

The Outline pane on the left looks as follows.

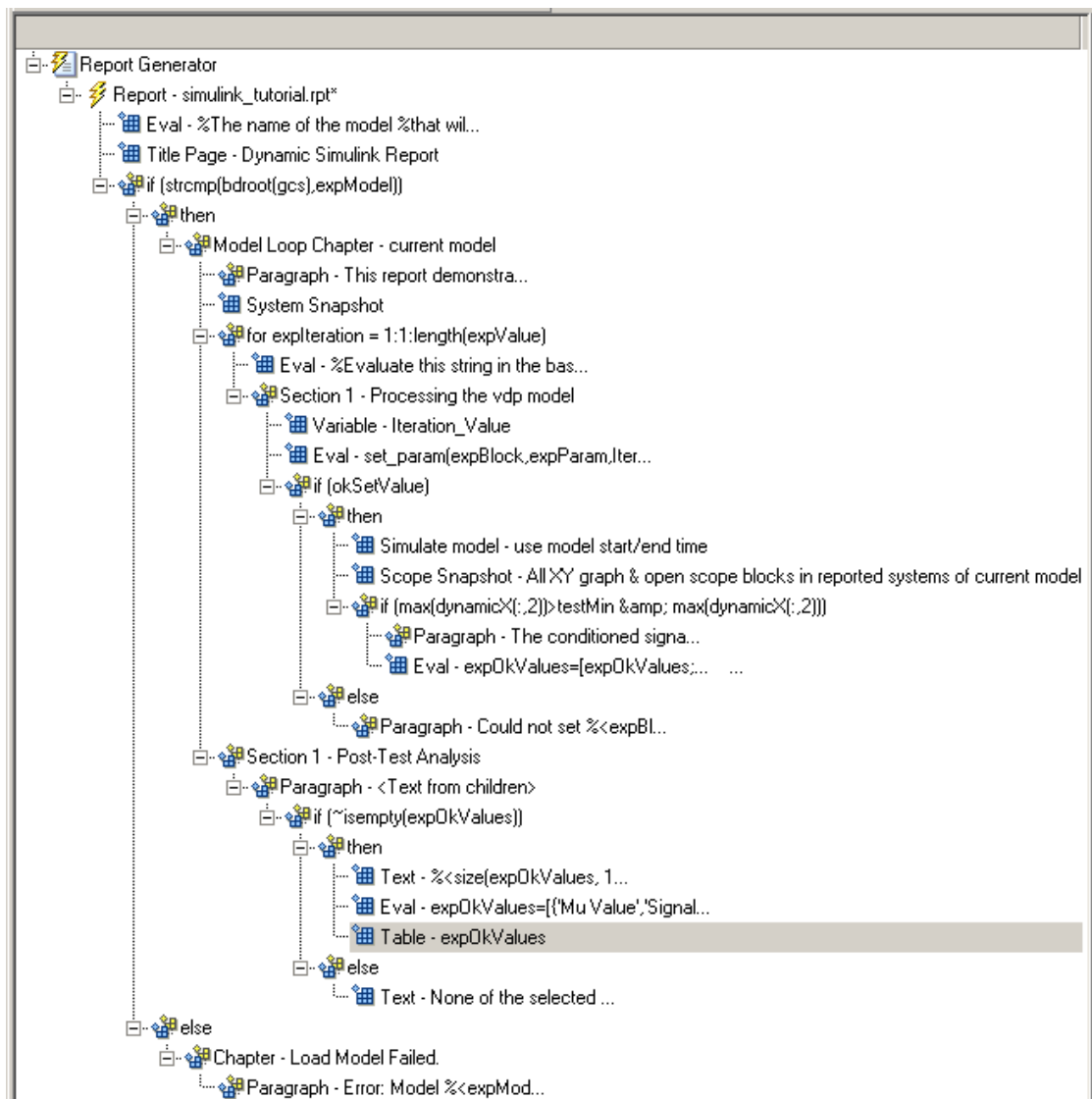

Generating the Report

Now the report includes all required components. To generate the report, click the **Report** icon on the toolbar. The following occurs:

- 1 A Message List window appears, displaying informational and error messages as the report is processed. Specify the level of detail you would like the Message List window to display while the report is being generated. Options range from 0 (least detail) to 6 (most detail). Click the selection list located under the title bar of the Message List window to choose an option, as shown in the following figure.

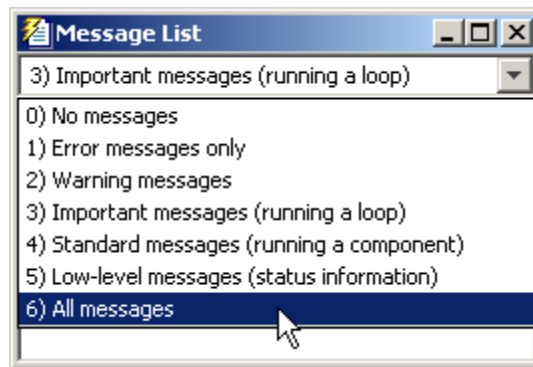

Message level 3 (Important messages) is used for the remainder of this example.

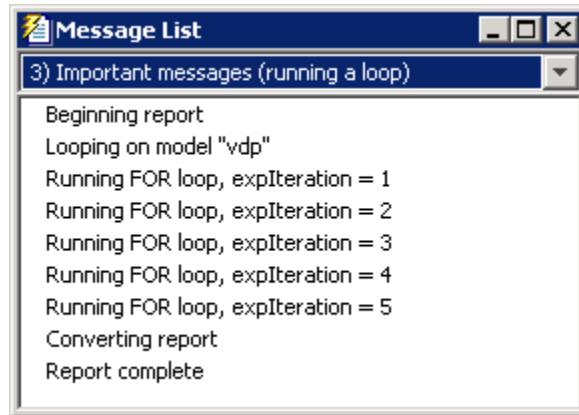

- 2** The vdp model appears. You can see each time it is simulated.
- 3** The scope window appears. The scope graph changes each time the parameter value changes.
- 4** Each component of the report is highlighted as it executes, in the Outline pane on the left in the Report Explorer window.

When the report is complete, Adobe Acrobat Reader opens your report in PDF format.

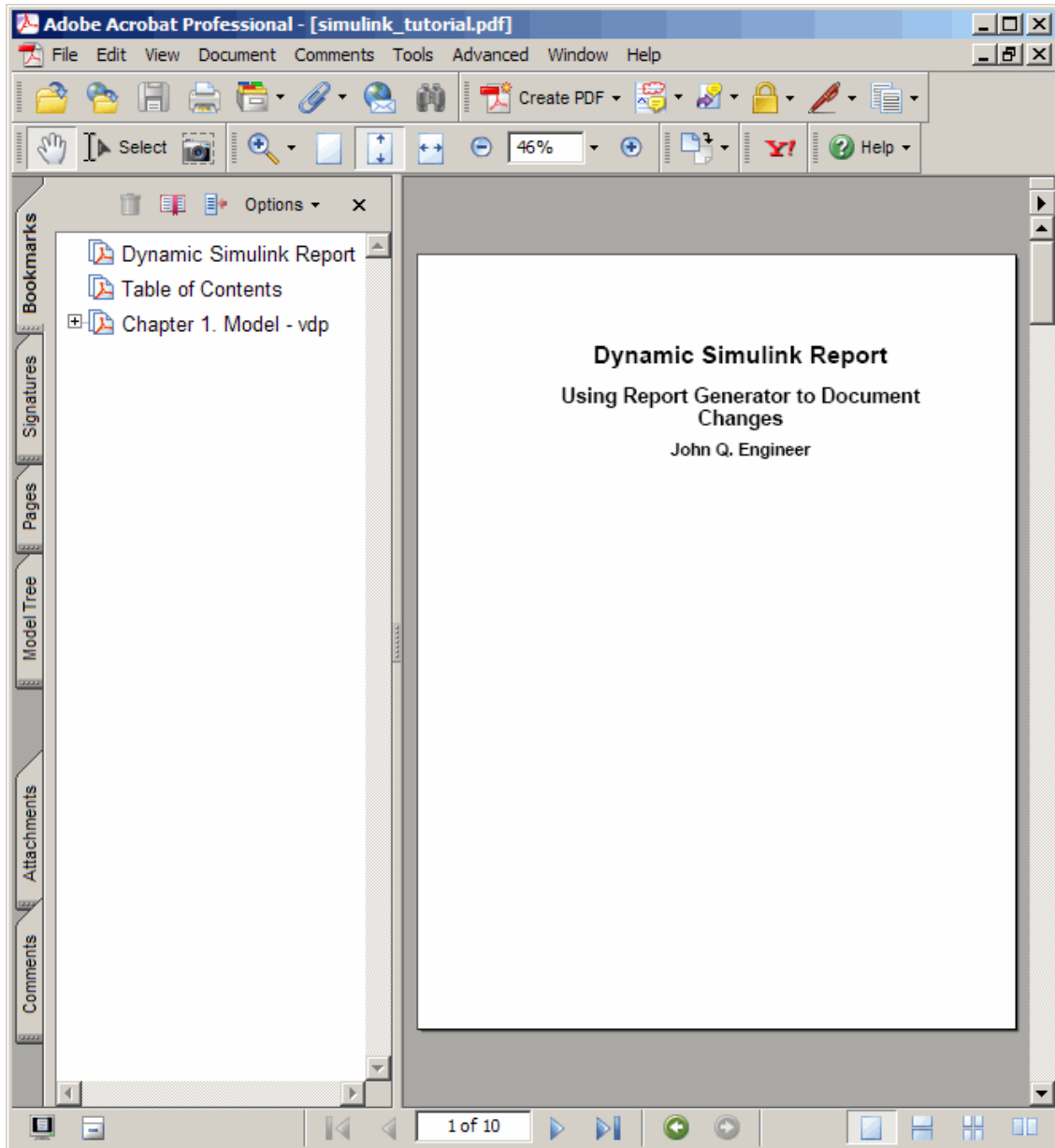

Generating Reports

- “Setting Report Output Options” on page 3-2
- “Converting XML Documents” on page 3-11
- “Creating Log Files” on page 3-14
- “Generating M-Code from Report Templates” on page 3-15
- “Working with Legacy Report Templates” on page 3-18
- “Troubleshooting” on page 3-20

Setting Report Output Options

In this section...
“Setting Preferences” on page 3-2
“Setting the Report File Directory” on page 3-3
“Setting the Report File Name” on page 3-4
“Setting the Report Format” on page 3-4
“Viewing and Printing Reports” on page 3-8
“Converting English Strings to Other Languages” on page 3-9
“Autosaving Report Templates” on page 3-9
“Regenerating Images” on page 3-9
“Including a Report Description” on page 3-9

Setting Preferences

Specify report output settings using the **Preferences** pane. To open this pane, click **File > Preferences**. A list of available options appears in the following table.

Option	Purpose
Format ID	Specify the report output format. Choices include Acrobat (PDF), Rich Text format, and Word document. The default is Web (HTML).
Extension	Automatically sets the file extension of the report file according to the value specified for Format ID. The default is html.
Simulink Images	Specify the format for Simulink images to include in the report. The default is PNG 24-bit image.
Stateflow Images	Specify the format for Stateflow charts to include in the report. The default is PNG 24-bit image.

Option	Purpose
HG Images	Specify the format for Handle Graphics® images to include in the report. The default is PNG 24-bit image.
View command	Specify the MATLAB command you want to use to view the report.
Visible in Report Explorer	Deselect this check box to make the current output format unavailable in the Report Explorer Interface. For example, if your specified report format is Word document and you deselect this check box, then the Microsoft Word document format is no longer available for reports created using the Report Explorer.
Use version 1.x environment	Choose this option to use previous versions of MATLAB Report Generator and Simulink Report Generator interfaces. For more information, see “Using Legacy Interfaces” on page 3-19.
Animate Report Explorer when generating reports	Select this check box if you want components in the Outline pane to be animated as the report generates. This box is selected by default.

Setting the Report File Directory

Choose a directory to which you have write privileges, to store the report file. A list of options appears in the following table.

Directory	Option
The same directory as the report template	Same as report template
The current working directory	Present working directory
Temporary directory	Temporary directory
Another directory	Custom. Use the Browse button (...) to select from a list of directories.

You can use %<VariableName> notation to specify a directory in the **Custom** text box. For more information, see “% Notation” on the Text component reference page in the MATLAB Report Generator documentation.

Setting the Report File Name

Images are placed in a directory with the same name as the report file. For example, testreport.html images are placed in a directory named testreport_files.

Choose a file name for the report file, using the options listed in the following table.

File Name	Option
The same file name as the report template	Same as report template (default)
A file name different from the report template name	Custom. Enter the name of the report.

Use %<VariableName> notation to specify a file name in the **Custom** text box. For more information, see “% Notation” on the Text component reference page in the MATLAB Report Generator documentation.

Setting the Report Format

Choose the report output format in the **File format** text box. For example, if you want to use Microsoft Word, choose Word document or Rich Text Format.

Report Format and Stylesheet

File format: Rich Text Format Very Large Type Print

Generation Options

View report after generation

Auto save before generation

Evaluate this string after generation:

Each output format has a default stylesheet associated with it. Specify the stylesheet in the text box next to the **File format** text box.

The following table shows which output format to use with different software, and which stylesheets you can use with each output format.

Viewer	Format	Description	Stylesheets
Adobe Acrobat Reader	Adobe Acrobat (PDF)	Produces a PDF that you can view using Adobe Acrobat Reader software	PDF (see “PDF Stylesheets” on page 3-5)
Web browser	Web (HTML) (default)	Use for publishing on the World Wide Web	Web (see “Web Stylesheets” on page 3-7)
Word processor	Rich Text Format (RTF) or Word Document	Compatible with most word-processing packages, including Microsoft Word software	Print (see “RTF (DSSSL Print) and Word Stylesheets” on page 3-8)
DocBook	DocBook (XML)	Produces a report in DocBook format	N/A

Tip To create and use customized styles, see “Creating Custom Stylesheets”.

PDF Stylesheets

PDF Stylesheet	Description
Standard Print	Displays title page, table of contents, list of titles

PDF Stylesheet	Description
Simple Print	Suppresses title page, table of contents, list of titles
Compact Simple Print	Minimizes page count, suppresses title, table of contents, list of titles
Large Type Print	Uses 12-point font (slightly larger than Standard Print)
Very Large Type Print	Uses 24-point font and landscape paper orientation
Compact Print	Minimizes white space to reduce page count
Unnumbered Chapters & Sections	Chapters and sections are not numbered
Numbered Chapters & Sections	Chapters and sections are both numbered
Paginated Sections	Sections are printed with page breaks
Custom Header	Lets you specify custom headers and footers
Custom Titlepage	Lets you specify custom title page content and presentation
Logo stylesheet for PDF	Lets you specify a logo, such as your company logo, in the header
Verbose Print	Lets you specify advanced print options

Web Stylesheets

Web Stylesheet	Description
Default HTML stylesheet	HTML on a single page
Simulink book HTML stylesheet	HTML on multiple pages; suppresses chapter headings and table of contents
Truth Table HTML stylesheet	HTML on multiple pages; suppresses chapter headings and table of contents
Multi-page Web	HTML, with each chapter on a separate page
Single-page Web	HTML on a single page
Single-page Unnumbered Chapters & Sections	HTML on a single page; chapters and sections are not numbered
Single-page Numbered Chapters & Sections	HTML on a single page; chapters and sections are numbered
Single-page Simple	HTML on a single page; suppresses title page and table of contents
Multi-page Simple	HTML on multiple pages; suppresses title page and table of contents
Multi-page Unnumbered Chapters & Sections	HTML on multiple pages; chapters and sections are not numbered.
Multi-page Numbered Chapters & Sections	HTML on multiple pages; chapters and sections are numbered

RTF (DSSSL Print) and Word Stylesheets

RTF or Word Stylesheet	Description
Standard Print	Displays title page, table of contents, list of titles
Simple Print	Suppresses title page, table of contents, list of titles
Compact Simple Print	Minimizes page count, suppresses title, table of contents, list of titles
Large Type Print	Uses 12-point font (slightly larger than Standard Print)
Very Large Type Print	Uses 24-point font and landscape paper orientation
Compact Print	Minimizes white space to reduce page count
Unnumbered Chapters & Sections	Chapters and sections are not numbered
Numbered Chapters & Sections	Chapters and sections are both numbered

Note Some Web and Print stylesheets include an automatically generated list of titles. The list of titles includes a list of table titles and a list of figures with titles.

Viewing and Printing Reports

To view your report after generation:

- To view the report automatically, select the **View report after generation** check box in the **Generation Options** section in the Properties pane on the right. When report generation is complete, the viewer associated with the report output format displays the report.
- To view the report manually, browse to the location specified in the **Report File Location** section in the Properties pane on the right, and open the file.

To print your report, select the **Print** option from the viewer.

Converting English Strings to Other Languages

Versions 2.0 and later of the MATLAB Report Generator and Simulink Report Generator software use the system language settings through the Sun™ Java™ interface; therefore, they should use the language specified on your system.

Alternatively, you can change the language directly in Java from the MATLAB command line. The following example sets the language to Italian:

```
java.util.Locale.setDefault(java.util.Locale.ITALY)
```

Alternatively, you can set the preferred language directly in your `.rpt` file:

- 1 Right-click the **Report** component and select **Send to Workspace**.

This displays the properties of the report, which are stored in the variable *ans*. Access the report's Language property from the command line through this variable. By default, Language is `auto`, which indicates that the system's default language is in use.

- 2 Override the default value of Language by setting this property to your desired language; for example, `en` for English or `it` for Italian.

Autosaving Report Templates

To automatically save the report template before you generate a report, select **Auto save before generation** from the **Generation Options** section of the Properties pane on the right.

Regenerating Images

By default, the **Regenerate Simulink and Stateflow Images** option in the **Generation Options** section of the Properties pane on the right is cleared. As a result, previously generated images are not regenerated each time you generate a report, so reports generate faster. If you make changes that affect a generated image, select this option.

Including a Report Description

Use the **Report Description** field in the Properties pane on the right to record notes and comments about your report template. This text appears in

the Properties pane on the right when you select a report template in the Outline pane on the left.

Converting XML Documents

In this section...
“Why Convert XML Documents?” on page 3-11
“Converting XML Documents Using the Report Explorer” on page 3-11
“Converting XML Documents Using the Command Line” on page 3-13
“Editing XML Source Files” on page 3-13

Why Convert XML Documents?

You can generate a report in a different output file format without regenerating it by using either the Report Explorer File Converter or the `rptconvert` command. These utilities convert DocBook XML source files created by the report-generation process into formatted documents such as HTML, RTF, or PDF.

Note The report-generation process can only convert XML source files created by the latest version of the software.

Converting XML Documents Using the Report Explorer

To open the **Convert** Properties pane:

- 1 In the Report Explorer, select **Tools > Convert source file**.

The Convert Source File Properties pane appears. All XML files in your current directory appear in the Options pane in the middle.

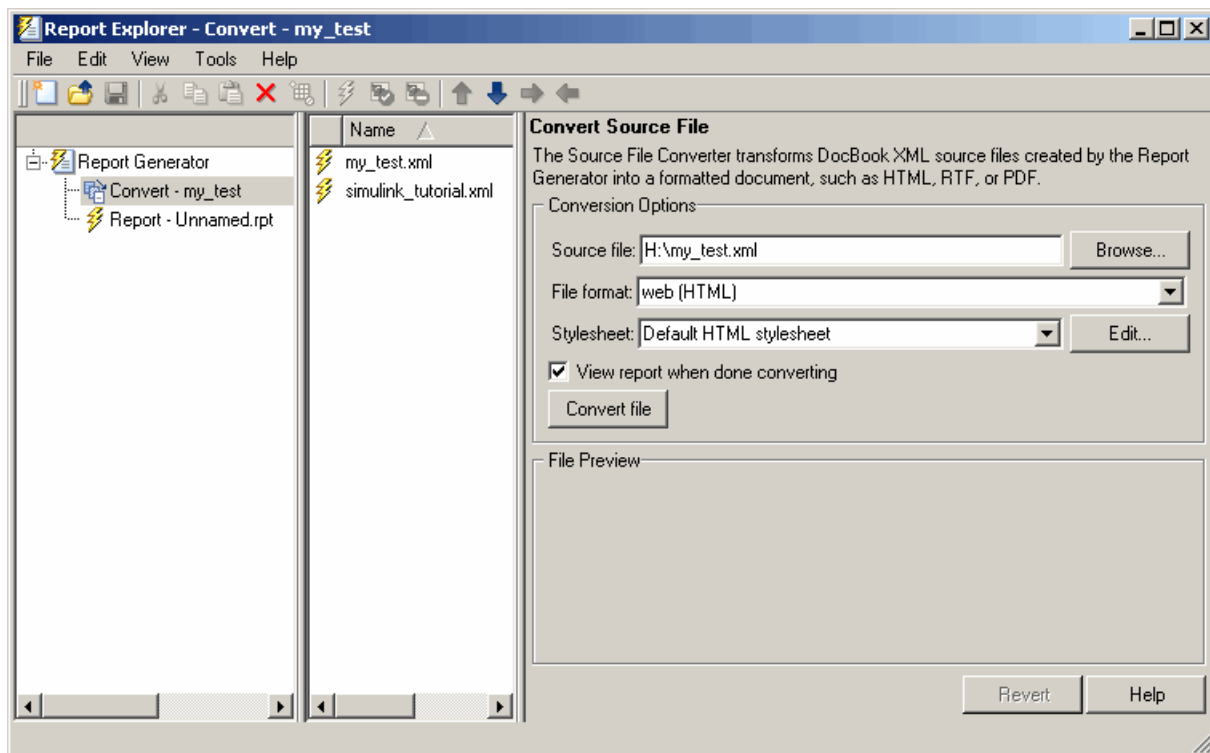

- 2 Select your XML source file using one of the following options:
 - Click **Browse** in the Properties pane on the right to browse to the location of your XML source.
 - Double-click a file name in the Options pane in the middle to automatically enter it into the **Source file** field in the Properties pane.
- 3 Select your output format and stylesheet:
 - a In the **File format** text box, select an output format.
 - b In the **Stylesheet** text box, select a stylesheet. The stylesheet choice depends on the specified output format. You can use a predefined or customized stylesheet.

For more information about available formats and predefined stylesheets, see “Setting the Report Format” on page 3-4.

For more information about customizing stylesheets, see “Creating Custom Stylesheets”.

- 4 Use the **View Report when done converting** check box to indicate whether you want to view the report after it has conversion.
- 5 To begin the conversion, click **Convert file**.

Converting XML Documents Using the Command Line

To convert files using the command line, use the `rptconvert` function. For more information, see the `rptconvert` reference page in the MATLAB Report Generator documentation.

Editing XML Source Files

Before you send a source file to the converter, edit it as text in the Report Explorer:

- 1 In the Outline pane on the left, open the File Converter.
- 2 Right-click **MATLAB Report Generator** and select **Convert source file**.
- 3 In the Options pane in the middle, select the source file to edit.
- 4 In the Properties pane on the right, click **Edit as text**.
- 5 Use the MATLAB Editor to edit and save the text.

Creating Log Files

A log file describes a report template's report-generation settings and components. A log file can be used for many purposes, including:

- As a debugging tool
- As a reference to a report template
- To share information about a report template through e-mail

A log file includes the following information:

- Report template outline
- Components and their attributes
- Generation status messages currently displayed in the **Generation Status** tab

To generate a log file, click **File > Log File**. An HTML version of the log file with the name `<report_template_file_name_log>.html` is saved in the same directory as the report template.

Generating M-Code from Report Templates

You can generate M-code versions of report templates in the form of an M-file (*.m). An M-file of a report template is useful for a variety of purposes, including generating reports and modifying report templates programmatically.

To generate an M-file, load a report template into the Report Explorer and click **File > Generate M-File**. After the M-file generates, it opens in the MATLAB Editor. The M-file is saved in the same location as the report template.

Generating Reports from M-files

This example generates an M-file from the `figloop_tutorial.rpt` report template, which is provided with the MATLAB Report Generator software. The example then uses the `report` function to generate a report from the M-file. For more information about this function, see the `report` reference page.

- 1** Start the Report Explorer by entering `report` in the MATLAB Command Window.
- 2** In the Options pane in the middle, double-click `figloop_tutorial.rpt` to open its report template.
- 3** In the Outline pane on the left, click `Report - figloop_tutorial.rpt` to select it.
- 4** In the Report Explorer menu bar, click **File > Generate M-File**.

The MATLAB Report Generator software generates M-code for the `figloop_tutorial.rpt` report template. It saves this code in the `buildfigloop_tutorial.m` file in the current directory. Part of this file appears in the following figure.

```
1 function [RptgenML_CReport1] = buildfigloop_tutorial
2     %BUILDFIGLOOP_TUTORIAL
3
4     % Auto-generated by MATLAB on 02-Jan-2008 11:15:08
5
6     % Create RptgenML.CReport
7     RptgenML_CReport1 = RptgenML.CReport('Description',...
8     ['A report which demonstrates advanced component types:',sprintf('\n'),' ',sprintf('\n'),
9     'Stylesheet','html-!SingleClearTitleToCLOT',...
10    'Format','html',...
11    'DirectoryType','pwd'];
12    % setedit(RptgenML_CReport1);
13
14    % Create rptgen.cfr_titlepage
15    rptgen_cfr_titlepage1 = rptgen.cfr_titlepage('Copyright_Date','1998',...
16    'Author','The MathWorks',...
17    'Subtitle','A Tutorial',...
18    'Title','The Figure Loop');
19    rptgen_cfr_text1 = rptgen.cfr_text('Content',...
20    'The Figure Loop produces a report which documents multiple figure windows. Each time t
21    set(rptgen_cfr_titlepage1,'AbstractComp',rptgen_cfr_text1);
22    rptgen_cfr_text2 = rptgen.cfr_text;
23    set(rptgen_cfr_titlepage1,'LegalNoticeComp',rptgen_cfr_text2);
24    rptgen_cfr_image1 = rptgen.cfr_image('FileName','');
25    set(rptgen_cfr_titlepage1,'ImageComp',rptgen_cfr_image1);
26    setParent(rptgen_cfr_titlepage1,RptgenML_CReport1);
```

5 To generate the `figloop_tutorial` report from this M-file, run the following command in the MATLAB Command Window:

```
report(buildfigloop_tutorial);
```

The MATLAB Report Generator software runs and displays the report.

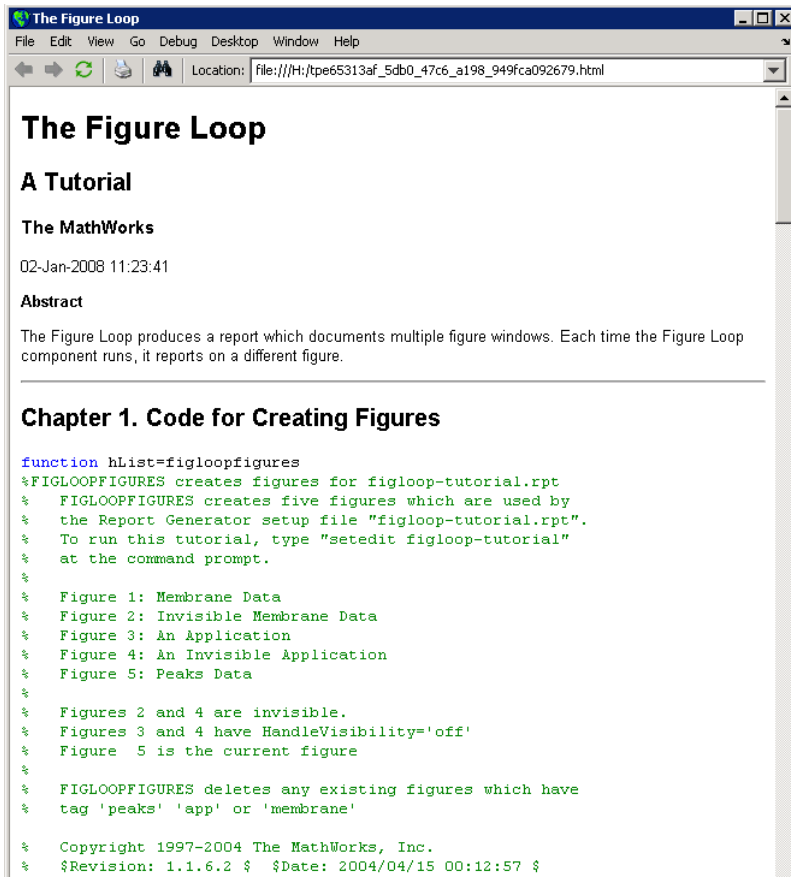

Working with Legacy Report Templates

In this section...
“What Are Legacy Report Templates?” on page 3-18
“Enabling Legacy Interfaces” on page 3-18
“Using Legacy Interfaces” on page 3-19

What Are Legacy Report Templates?

Legacy report templates are files that you created in previous versions of the MATLAB Report Generator or Simulink Report Generator software. You can load legacy report templates in the current version of the Report Explorer. Alternatively, you can use earlier versions of the product interfaces to work with legacy report templates.

Enabling Legacy Interfaces

Enable the previous versions of the interfaces at the MATLAB command line:

```
RptgenML.v1mode(true)
```

The result is:

```
ans =
```

```
1
```

A logical 1 indicates that Version 1 mode is on. To turn off Version 1 mode, enter:

```
RptgenML.v1mode(false)
```

The result is:

```
ans =
```

```
0
```

A logical 0 indicates that Version 1 mode is off.

Using Legacy Interfaces

When you enable Version 1 mode, you can use previous versions of MATLAB Report Generator or Simulink Report Generator interfaces.

When using earlier versions of these interfaces, the following restrictions apply:

- You cannot use a report template created in the latest version of the MATLAB Report Generator or Simulink Report Generator software with earlier interfaces. If you save a legacy report template in the latest version of the software, you can no longer work with the same report template in the old interface.
- You cannot use the old interfaces with the latest version of the MATLAB Report Generator or Simulink Report Generator software. The Report Template Editor can coexist with the Report Explorer, but The MathWorks does not recommend using these interfaces together.

Troubleshooting

In this section...
“Managing Memory Usage” on page 3-20
“Displaying HTML Reports on UNIX Systems” on page 3-21

Managing Memory Usage

By default, the MATLAB software sets a limit of 100 MB on the amount of memory the Sun Java Virtual Machine (JVM™) software can allocate. The memory that the report generation process uses to build a document must fit within this limit. If you are having trouble processing large reports, it might be helpful to increase the amount of memory that MATLAB Report Generator and Simulink Report Generator software can allocate. See the following sections for more information.

Running the MATLAB Software Without a Desktop

One way to increase the amount of JVM memory available to the MATLAB Report Generator and Simulink Report Generator software is to run the MATLAB software with `-nodesktop` mode enabled.

Note This option is available on UNIX® platforms only. (UNIX is a registered trademark of The Open Group in the United States and other countries.)

Increasing the MATLAB JVM Memory Allocation Limit

Increase the amount of JVM memory available by increasing the MATLAB JVM memory allocation limit.

- 1 Create a file named `java.opts`. In this file, include the `-Xmx` option, specifying the amount of memory you want to allocate to the JVM software. For example, to increase the JVM memory allocation limit to 128 MB, use the following syntax in the `java.opts` file:

```
-Xmx128m
```

Caution To avoid virtual memory thrashing, never set the `-Xmx` option to more than 66% of available physical RAM.

- 2** Put the `java.opts` file into the appropriate directory. Where you put the file depends on what operating system you are running.
 - On UNIX systems, put the `java.opts` file in the directory where you intend to start the MATLAB software session, and navigate to that directory before doing so.
 - On Microsoft Windows® systems:
 - 1** Put the `java.opts` file in a directory the directory where you intend to start the MATLAB software session.
 - 2** Create a shortcut to the MATLAB software.
 - 3** Right-click the shortcut and select **Properties**.
 - 4** In the Properties dialog box, specify the MATLAB startup directory for the name of the directory in which you created the `java.opts` file.
 - On Apple® Mac OS systems, put the `java.opts` file into the `/Applications/matlab` directory.

Displaying HTML Reports on UNIX Systems

HTML reports may not automatically display on some UNIX platforms. To work around this issue, configure the MATLAB Report Generator software to launch an external browser:

- 1** In the Report Explorer, click **File > Preferences**.
- 2** Enter the following text in the **View command** field:

```
web(rptgen.file2urn('%file name'), '-browser')
```

Where *file name* is the name of your report template file.

You may also need to modify the `docopt.m` file to specify which Web browser you want to use. For more information, see the `docopt` function in the MATLAB documentation.

Exporting Simulink Models to Web Views

- “What Are Web Views?” on page 4-2
- “Exporting Models to the Web” on page 4-3
- “Navigating Web Views” on page 4-7
- “Tutorial: Creating Web Views of Simulink Models” on page 4-11
- “Troubleshooting” on page 4-22

What Are Web Views?

A Web view is an interactive rendition of a model that you can view in a Web browser. You can use Web views to navigate hierarchically to specific subsystems and see properties of blocks, signals, and scopes. You can zoom in and out, pan, and fit your model to your view using the same keyboard shortcuts that you use in Simulink and Stateflow editors.

You need the Simulink Report Generator software to create Web views. Web views require that your Web browser support Adobe SVG, implemented natively or through a plug-in; they do not require The MathWorks™ products to be installed. Therefore, Web views are useful for presenting models to audiences and for sharing models with colleagues who do not have The MathWorks products installed.

Exporting Models to the Web

In this section...
“Opening the Export Interface” on page 4-3
“Setting Export Options” on page 4-3
“Generating and Reviewing Web Views” on page 4-5

Opening the Export Interface

You can export a model to a Web view using either a Simulink Report Generator dialog box or a Report Explorer pane.

To Open the export interface from ...	Use ...	Export interface opens as...
Report Explorer	Tools > Export to Web	Report Explorer
Simulink model window	File > Export to Web	Dialog box
Stateflow editor	File > Export to Web	Dialog box
Command line	The <code>slwebview</code> function, with no arguments	Report Explorer

Setting Export Options

You can set options that specify which Simulink systems or Stateflow charts to export to a Web view, including:

- Whether to export Simulink systems or Stateflow charts that include (or are children of) the current system or chart. For more information, see “Include Systems” on page 4-4.
- Which masked blocks, if any, to include. For more information, see “Look Under Masks” on page 4-4.
- Whether to follow links to library blocks. For more information, see “Follow Library Links” on page 4-5.

- Whether to follow model reference blocks. For more information, see “Follow Model Reference Blocks” on page 4-5.

Tip This section describes how to specify Web view export options using the Web Views dialog box. For information about how to specify these options using the command line, see the `slwebview` function reference page.

Include Systems

Specifies which Simulink systems or Stateflow charts to export.

Include Systems Option Value	Meaning
Current	Export only the Simulink system that is open in the model window or the Stateflow chart that is open in the diagram editor
Current and above	Export the current Simulink system or Stateflow chart and all systems or charts that contain it
Current and below	Export the current Simulink system or Stateflow chart and all subsystems or subcharts that it contains
All (Default)	Export all Simulink systems or Stateflow charts in the model

Look Under Masks

This option is available only when you choose `Current and below` or `All` for **Include Systems**. It specifies which masked blocks, if any, to export from Simulink subsystems or Stateflow subcharts.

Look Under Masks Option Value	Meaning
No masked blocks	Do not export any masked blocks

Look Under Masks Option Value	Meaning
Masks with no workspace and no dialog (Default)	Export only graphical masked blocks—those that have no workspaces and no dialog boxes
Masks with no dialog	Export only functional masked blocks—those that have no dialog boxes
All masked blocks	Export all masked blocks

Follow Library Links

Specifies whether to follow links into library blocks.

Follow Library Links Option Value	Meaning
Selected	Follow links into library blocks
Unselected (Default)	Do not follow links into library blocks

Follow Model Reference Blocks

Specifies whether to follow links into referenced models.

Follow model reference blocks Option Value	Meaning
true	Follow links into referenced models
false (Default)	Do not follow links into referenced models

Generating and Reviewing Web Views

The Web view export process exports the system or chart that is visible at the time you click **Export Model**. If you change the visible system or chart while the Report Explorer Web view export pane is visible, the Report Explorer pane does not automatically change to show information about the newly visible system. To update the Report Explorer pane, click **Refresh**.

The Web view export dialog box or the Report Explorer displays a list of layers—that is, Simulink systems or Stateflow charts—to export. The list of layers depends on the export options you specify, as described in “Setting Export Options” on page 4-3.

To generate a Web view of all layers in the model, click **OK** in the Web View dialog box, or click **Export Model** in the Report Explorer pane. This action generates two sets of files in the current MATLAB directory:

- An HTML file to appear in a Web browser.
- A directory with the same name as the HTML file. This directory contains supporting files, such as `svg` and `png` files.

To send the Web view to another computer, include both the HTML file and the directory of supporting files. Package these items into a zip file for transfer.

When you generate a Web view, it appears in a Web browser by default. You can suppress the display by setting the `'ViewFile'` option to `false`.

Navigating Web Views

In this section...

“Displaying Web Views” on page 4-7

“Viewing the Current Layer” on page 4-7

“Viewing Other Layers” on page 4-8

“Viewing All Layers” on page 4-9

Displaying Web Views

To display Web views, you need a Web browser with support for Scalable Vector Graphics (SVG), implemented natively or through a plug-in. For detailed information on software requirements and limitations for using Web views, see the *Simulink Report Generator Release Notes*.

A Web view display consists of:

- A graphical display of the current layer (Simulink system or Stateflow chart)
- A hierarchical treeview browser for easy navigation through layers
- Four navigation buttons at top left
- Menu of navigation commands, which appears when you move the mouse over the leftmost button
- Shortcut menu, which appears in some browsers when you right-click the current layer

Viewing the Current Layer

Display an example Web view of the Simulink Automatic Climate Control System demo model by typing the following commands at the MATLAB command prompt:

```
sldemo_auto_climatecontrol;  
slwebview(gcs)
```

As you move the mouse over the current layer, parameter names and values appear for each system, chart, block, and line. Use the mouse, menu commands, keyboard accelerators, and the arrow keys on your keyboard to pan and zoom within the current layer.

Action	Navigation Menu Command	Shortcut Menu Command	Keyboard Accelerator
Zoom in	Zoom in	Zoom in	<u>R</u>
Zoom out	Zoom out	Zoom out	<u>V</u>
Zoom to normal size (100%)	Zoom to 100%	None	<u>1</u>
Zoom to largest size that fits in browser window	Zoom to full screen	Zoom to full screen	<u>F</u>
Pan up	Pan up		<u>E</u>
Pan down	Pan down		<u>C</u>
Pan left	Pan left		<u>D</u>
Pan right	Pan right		<u>G</u>
Pan with mouse (drag layer while in panning mode)	Pan with mouse (click to toggle panning mode)	Pan with mouse (click to toggle panning mode)	<u>P,Q</u>, or SPACEBAR (press to enter panning mode; release to exit panning mode)

Note The shortcut menu command **Find text** searches for a text string in the current layer. This command is only available in the Microsoft Internet Explorer Web browser.

Viewing Other Layers

Click a particular layer's subsystem or subchart to make it the current layer. The current layer is also selected in the treeview browser, and its subsystems

or subcharts appear in the treeview browser hierarchically. If blocks in your current layer are linked to libraries, the Web view shows to which libraries they belong.

Note If your current layer has no subsystems or subcharts, it does not appear in the treeview browser.

As you move the mouse over an exported subsystem or subchart, it is highlighted or the cursor changes, depending on which Web browser you are using. You also see the following visual cues that enable you to assess your location in the model quickly:

- The subsystem or subchart's corresponding icon in the treeview browser is also highlighted, showing to where in the hierarchy you have navigated.
- The names of the subsystem or subchart's parent systems are grayed out and italicized in the treeview browser.

You can use the navigation buttons at the top left to view other layers.

Action	Navigation Button
View the previous layer in the view history	View previous
View the top-level layer	View home
View all layers in one window	View all layers

Viewing All Layers

Click the **View all layers** navigation button to view all layers in one window. The layers appear in the Web browser as thumbnail images. You can click a given layer to view details about it. Clicking the **View all layers** button again returns to the previous view.

Tip You can also view all layers by selecting the **Show all layers** command on the navigation and shortcut menus, and by using the X keyboard accelerator.

Tutorial: Creating Web Views of Simulink Models

In this section...

“About This Tutorial” on page 4-11

“Specifying Web View Export Options” on page 4-11

“Exporting Models” on page 4-13

“Navigating Web Views” on page 4-15

About This Tutorial

This tutorial takes you through the steps required to export a Simulink model to a Web view. If you have a detailed model of your own, you can use it for this example. Otherwise, use the example provided in this section.

There are several ways to create a Simulink model Web view. This tutorial creates a Web view from the Simulink model window using the `sldemo_auto_climatecontrol` model, which is provided with the Simulink software. This model simulates the working of an automatic climate control system in a car.

You do not need to know the Simulink product to follow this tutorial.

Specifying Web View Export Options

Before creating the Web view, specify export options:

- 1 Start a MATLAB software session.
- 2 At the command prompt, enter `sldemo_auto_climatecontrol` to open the Simulink model.
- 3 Click **File > Export to Web**.

A Web view window that includes data about the current model appears.

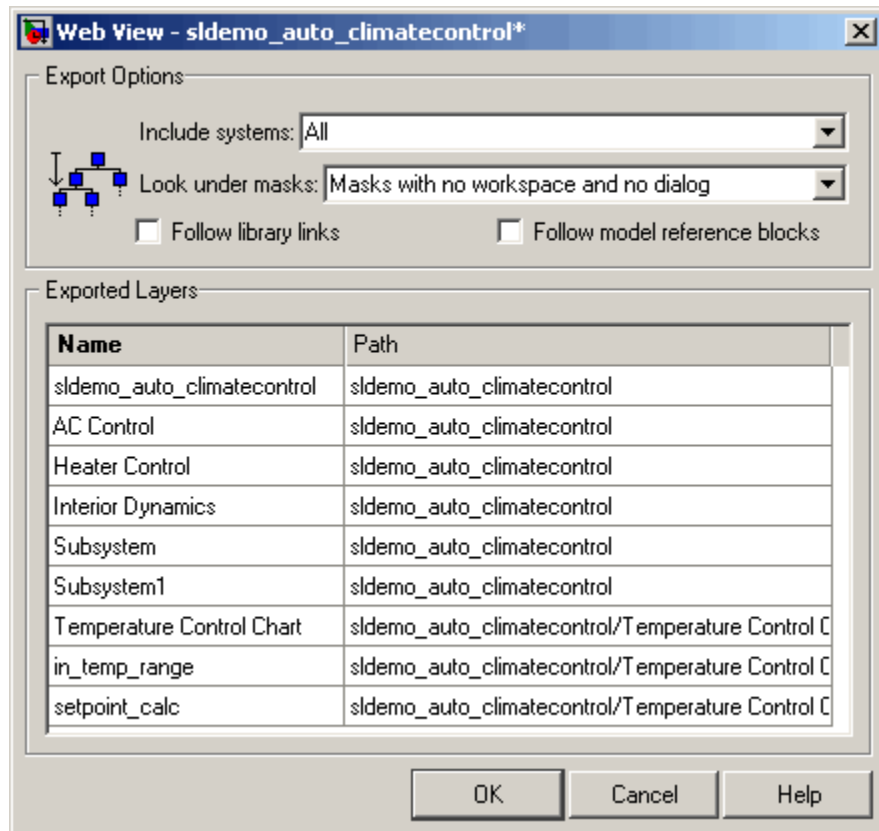

- 4** In the **Include systems** selection list, select **All** to export all systems in this model.
- 5** In the **Look under masks** selection list, select **Masks with no workspace and no dialog** to export only graphically masked blocks.
- 6** Leave the **Follow library links** and **Follow model reference blocks** check boxes cleared.

Exported Layers appears in the lower part of the Web View window. This area lists the names of the systems to export to the Web view, along with their Simulink paths. Because you selected **All** in the **Include systems** selection list, all layers in the `sldemo_auto_climatecontrol` model appear.

Exporting Models

Export the model to a Web view:

- 1 Click **OK** in the Web View window.

A browser window opens.

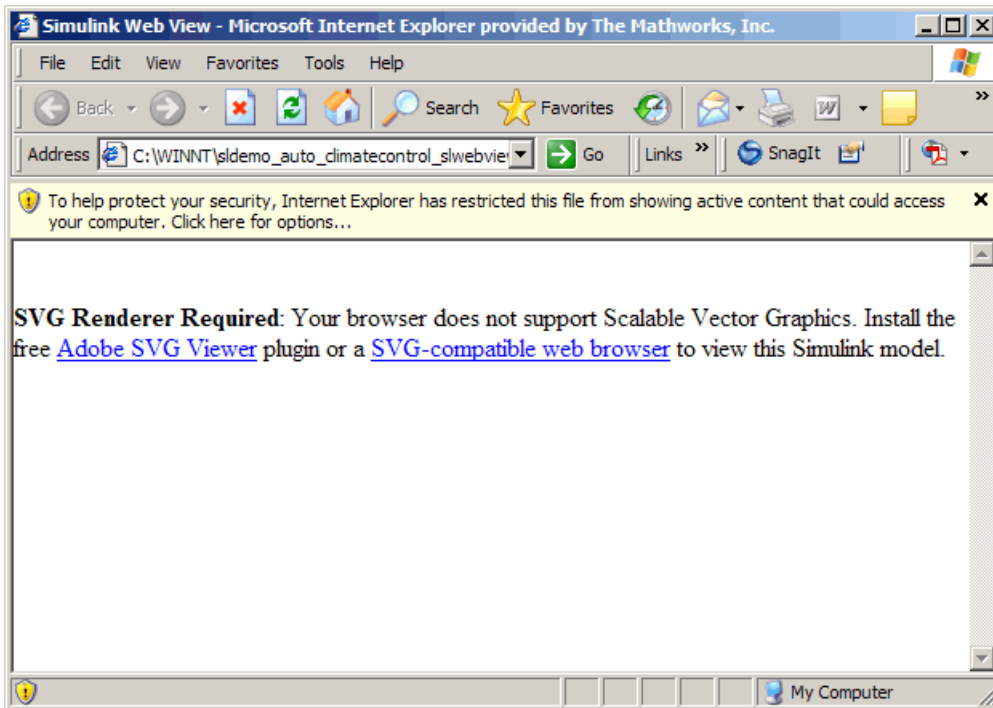

Note Scalable Vector Graphics (SVG) is required for Web views. The screen shots in this tutorial use Microsoft Internet Explorer Web browser with the SVG plug-in installed. Mozilla Firefox has native support for SVG. For details on SVG, see “Browser Requirements for Web Views” on page 1-12.

- 2 Hover over the error message at the top of the screen.

4 Exporting Simulink® Models to Web Views

The error message background changes color.

- 3 Left-click the error message. A context menu appears.

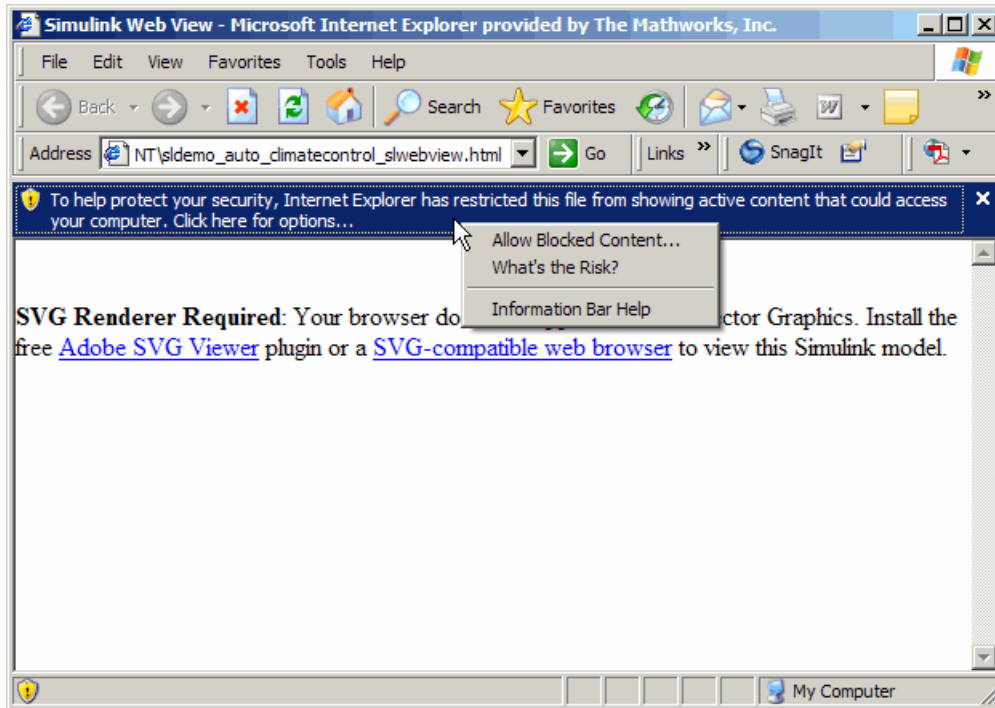

- 4 Select **Allow Blocked Content** from the context menu.

The following security warning appears.

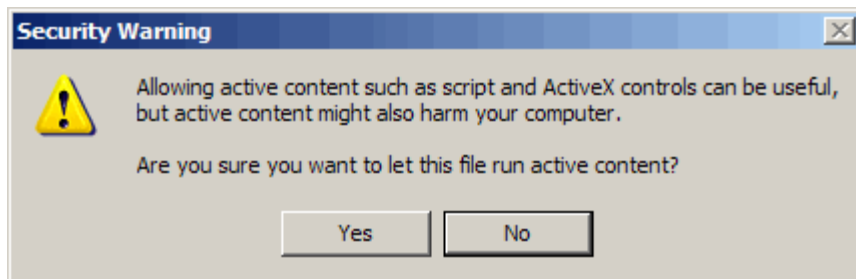

5 Click Yes.

The Web view of the model appears in the browser window.

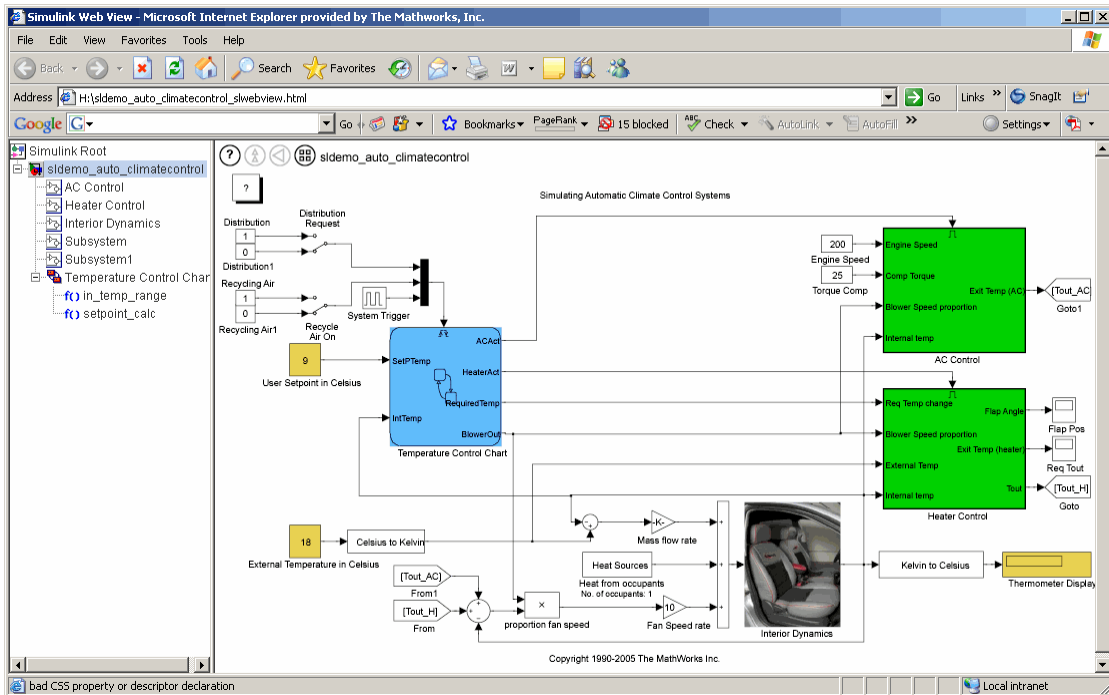
**Navigating Web Views**

You can navigate Web views in ways similar to how you navigate models in the Simulink GUI. The following steps help you experiment with the types of navigation that are available.

- 1 Notice the four navigation icons in the upper-left corner of the browser window.

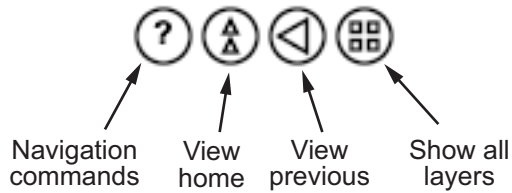

- 2 Hover over the Navigation Commands icon  to see a list of keyboard shortcuts that allow you to move around the current window.

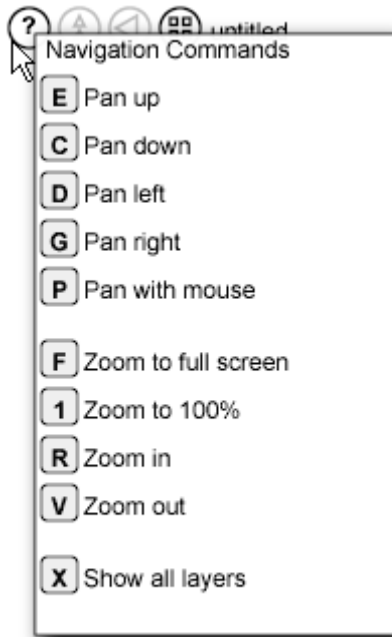

- 3 Press some of the keyboard keys listed here to see how the model in the Web view reacts.
- 4 Hover over the Temperature Control Chart diagram.

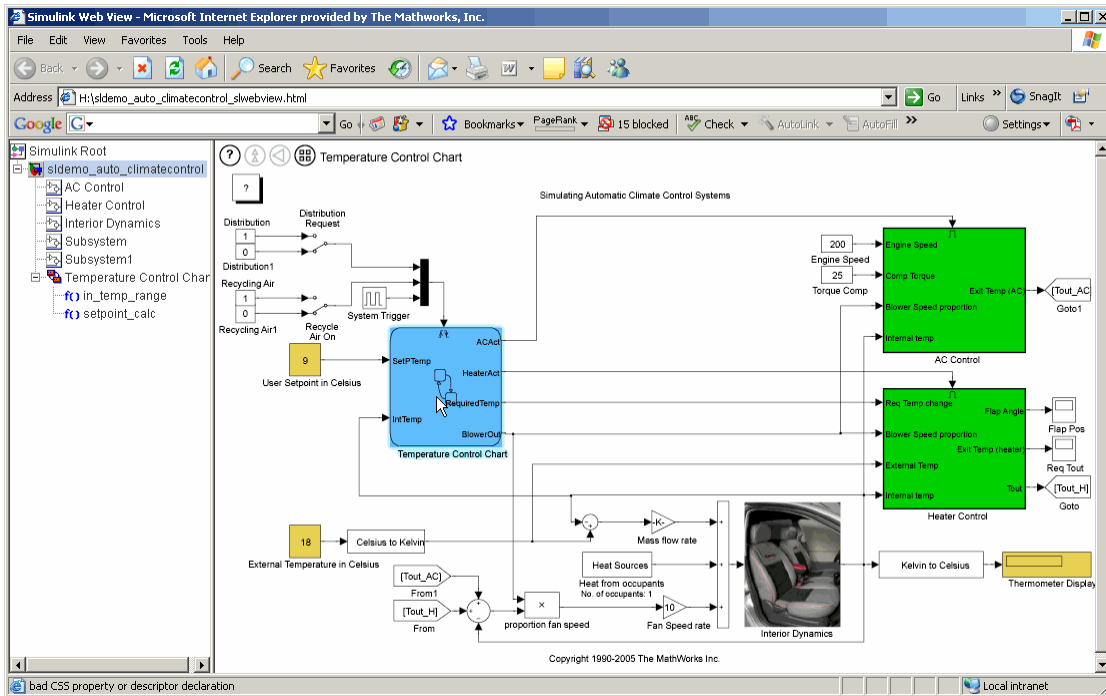

The name next to the navigation icons becomes Temperature Control Chart.



5 Hover over the System Trigger block.

The name next to the navigation icons changes to System Trigger.



In addition, the block parameter values for the System Trigger block appear.

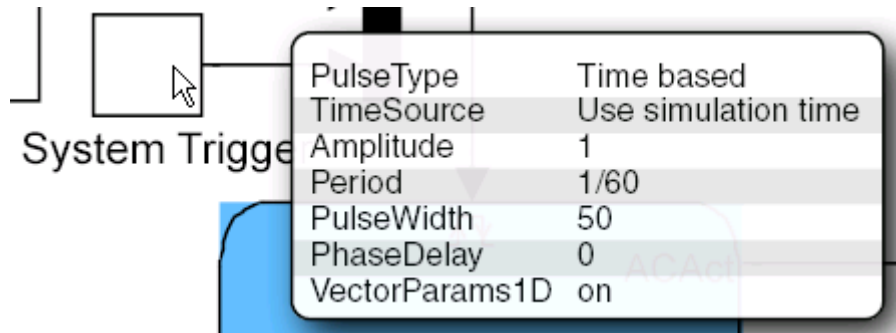

- 6 Hover over other blocks and subsystems in the model and observe the results.
- 7 Click the Temperature Control Chart.

The details of this Stateflow chart appear, and the middle two navigation icons are now enabled:

- The **View Home** icon takes you up to the top level of the model.
- The **View Previous** icon takes you up one level in the model.

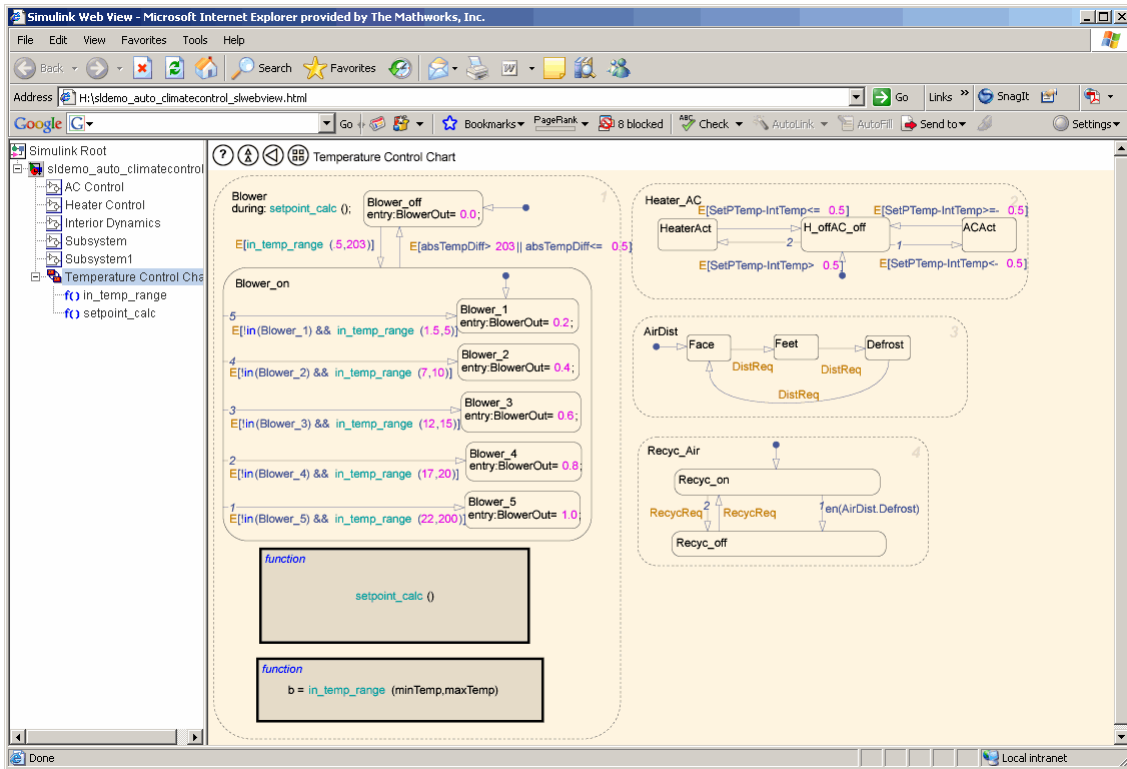

8 Click the setpoint_calc box in the Stateflow chart to see the details of that block.

4 Exporting Simulink® Models to Web Views

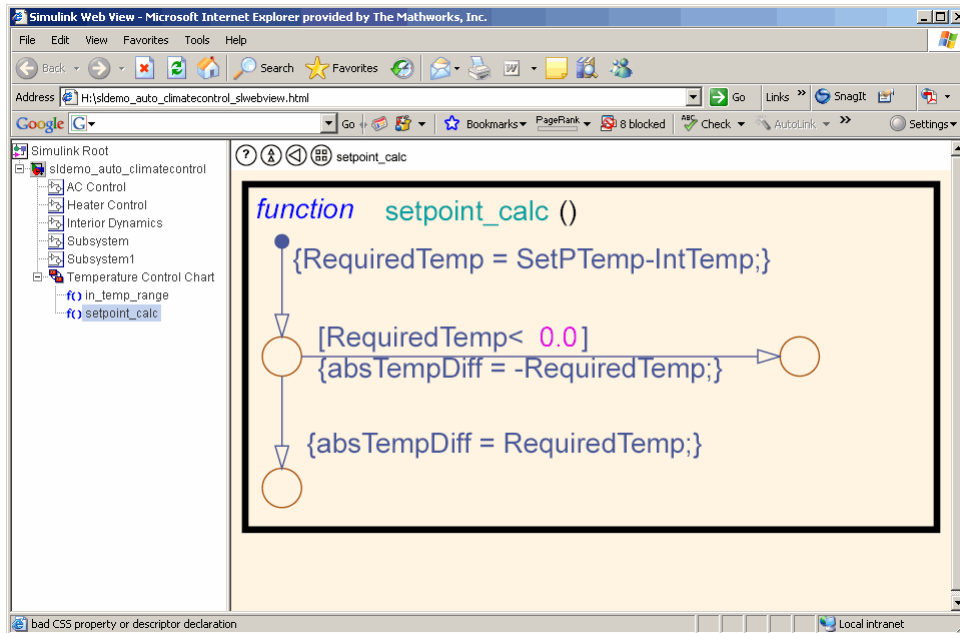

9 Click the **View home** icon to return to the model's top layer.

10 Click the **Show all layers** icon. An overall view of the model appears.

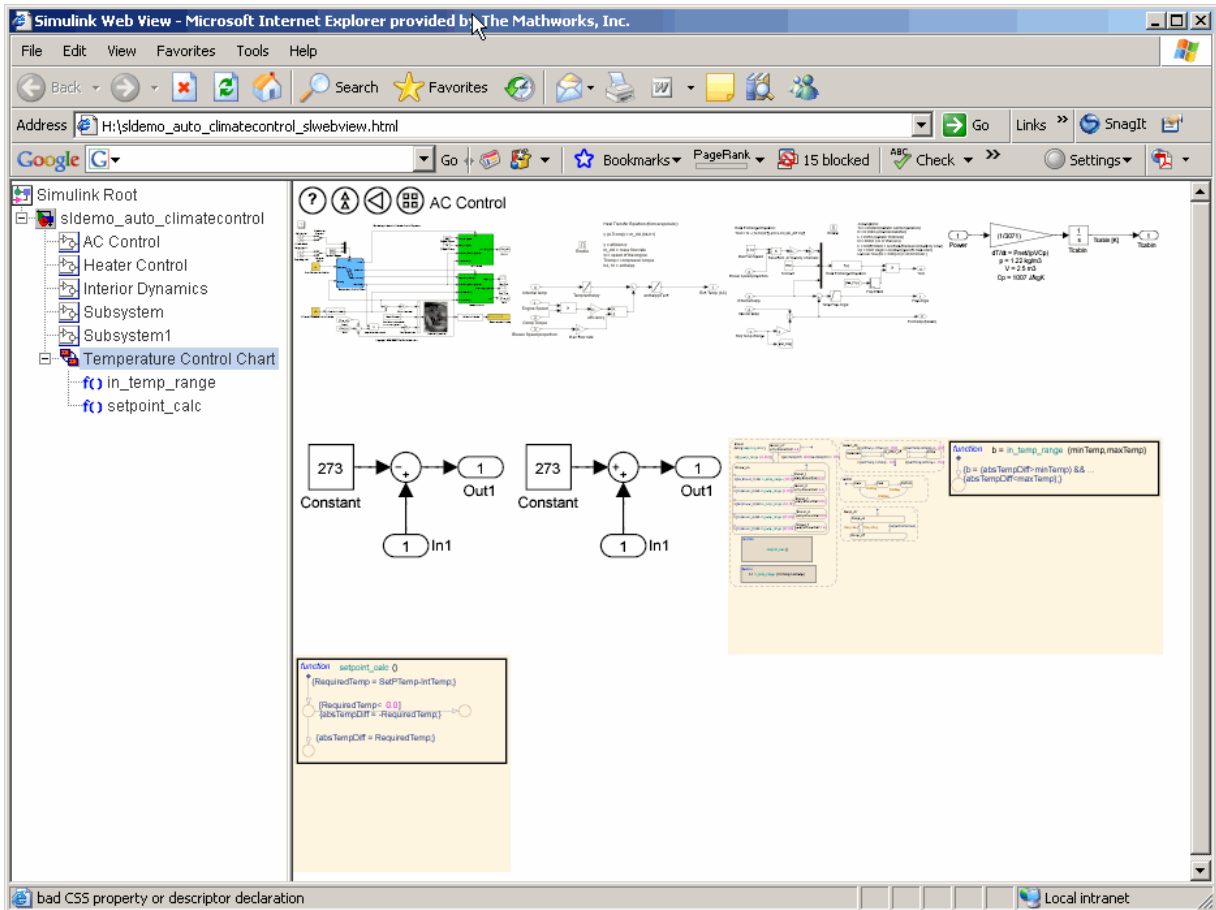

This high-level view of the model shows all layers of the model. In this figure, the arrow is hovering over the AC Control layer.

Try opening other Simulink models and exporting them to Web views, and experiment with the results.

Troubleshooting

Addressing Web View Display Issues

Exporting a Simulink model to a Web view may produce the following error:

```
[Thu Aug 23 15:20:04 2007] [alert] [client 127.0.0.1]
/webserver/mydir/simulink_model_slwebview_files/.htaccess:
IndexIgnore not allowed here
```

This results in your Web browser failing to display the Web view.

This issue occurs because of settings specified in the `.htaccess` file in your Web browser's root directory. This file contains the Apache Web Server settings for your Web server host. To fix this problem, delete this file or remove the `IndexIgnore *` line from it.

Working with Components

- “About Components” on page 5-2
- “Working with Looping Components” on page 5-3
- “Working with Property Table Components” on page 5-9
- “Working with Summary Table Components” on page 5-21

About Components

Components are self-contained, modular MATLAB objects that control the report-generation process and insert elements, such as tables, lists, and figures, into a report template. You use components to customize the appearance and output of reports.

The following sections provide examples of how to use different types of components.

Working with Looping Components

In this section...

“About Looping Components” on page 5-3

“Editing the Figure Loop Tutorial Report Template” on page 5-3

“About Figures” on page 5-3

“Figure Properties” on page 5-5

“Editing Figure Loop Components” on page 5-6

About Looping Components

A *looping component* runs its child components a specified number of times. Numerous looping components are available, including logical loops and Handle Graphics loops. Most loops behave similarly; the Figure Loop used in this example is representative of many types of loops.

The Figure Loop component runs its child components several times. In each iteration, it applies its child components to Handle Graphics figures. The `figloop-tutorial` report template, which is provided with the MATLAB Report Generator software, creates a report that documents multiple Handle Graphics figures.

For more information on Handle Graphics figures, see “Understanding Handle Graphics Objects” in the MATLAB getting started documentation.

Editing the Figure Loop Tutorial Report Template

To edit the figure loop tutorial report template, enter the following command at the MATLAB command prompt:

```
setedit figloop-tutorial
```

About Figures

It is important to understand the following concepts to use this tutorial:

- **Invisibility.**

Invisible figures do not appear on screen. They exist, but they are hidden; that is, the `visible` property of these figures is `'off'`. To make a given figure visible, set its `visible` property to `'on'`.

Some of the figures used in this example are invisible. To see this, enter the command `figloopfigures` at the MATLAB command line. Figures 1, 3, and 5 appear, but Figures 2 and 4 do not because they are invisible.

- **The `HandleVisibility` parameter.**

The `HandleVisibility` parameter of a Handle Graphics figure allows you to control the availability of the object's handle from the command line and from within callback routines in the MATLAB software. Valid values for this parameter are `'on'` and `'off'`.

To list all figures currently in your workspace whose `HandleVisibility` parameter is `'on'`, enter the following command at the MATLAB command line:

```
get(0, 'children')
```

The result is:

```
ans =  
    5  
    1  
    2
```

This indicates that `HandleVisibility` is `'on'` for figures 1, 2, and 5.

To set `HandleVisibility` to `'off'`, enter the following command at the MATLAB command line:

```
set(handle, 'HandleVisibility', 'off')
```

Where the handle of a figure is the figure number.

- **Tags.**

You can set *tags*, or labels, on Handle Graphics figures. Tags do not appear on their associated figures. By default, figure tags are empty.

To see a given figure's tag, enter the following at the MATLAB command line:

```
get(handle, 'tag')
```

Where the `handle` of a figure is the figure number.

For example, to see whether Membrane Data has a tag, enter the following at the MATLAB command line:

```
get(1, 'tag')
```

The result is:

```
ans =
    membrane
```

This indicates that figure 1 has a tag called `membrane`.

Figure Properties

The following table shows the values for the properties of the figures used in this tutorial.

Name	Handle	Visible	HandleVisibility	Tag
Membrane Data	1	on	on	membrane
Invisible Membrane Data	2	off	on	membrane
An Application	3	on	off	app
An Invisible Application	4	off	off	app
Peaks Data	5	on	on	peaks

To display the Handle Graphics figures, enter the following at the MATLAB command line:

```
figloopfigures
```

The figures `Membrane Data`, `An Application`, and `Peaks Data` appear on the screen. `Invisible Membrane Data` and `An Invisible Application` do not because they are invisible.

Editing Figure Loop Components

Select the `Figure Loop` component from the `Outline` pane on the left. The `Properties` pane for the `Figure Loop` component appears.

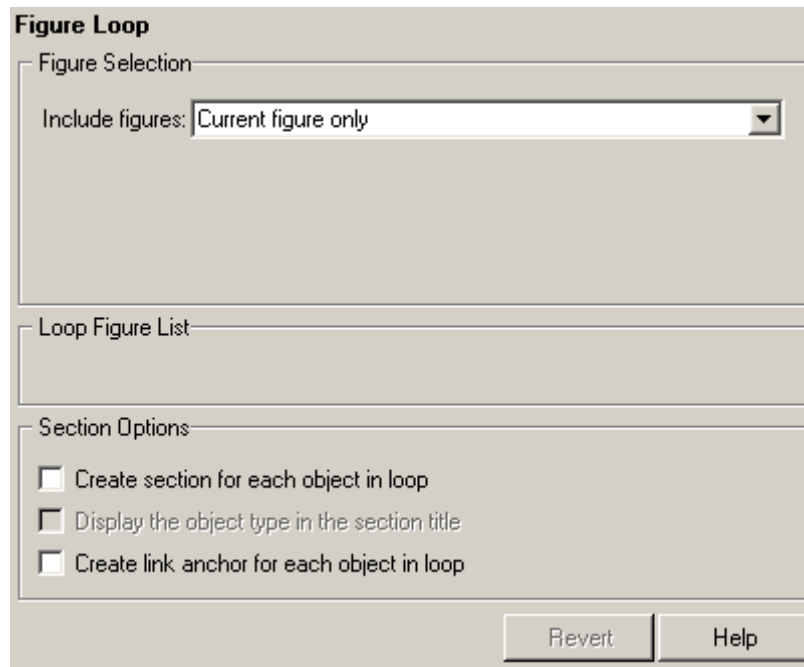

Looping on the Current Figure

To include only the current figure in the report, select `Current figure only` from the **Include figures** selection list. In this case, “current figure” refers to the figure that is current when the report generates. This may not be the same figure you selected as the current figure in the `Report Explorer` before report generation. For example, if the report-generation process creates figures in your report, the last figure created with `HandleVisibility` set to 'on' is the current figure.

Looping on Visible Figures

To include snapshots of all visible figures in your report, select **Visible figures** in the **Include figures** selection list. This option inserts a snapshot and Property Table for all figures that are currently open and visible.

Including only Figures with `HandleVisibility='on'`.

- 1 Select the **Data figures only (Exclude applications)** option to exclude figures from the loop whose `HandleVisibility` parameter is 'off'.
- 2 Click the **Report** button to generate the report.

The Membrane Data and Peaks Data figures appear in the generated report.

Including All Figures.

- 1 Clear the **Data figures only (Exclude applications)** option.
- 2 Click **Report** to generate the report.

All figures, regardless of the value of their `HandleVisibility` parameter, appear in the report.

Looping on Figures with Tags

To include figures specified tags in the report:

- 1 Select the **All figures with tags** option in the **Include figures** selection list.
- 2 Specify a tag in the text box.
- 3 Click **Report** to generate the report.

All figures with the specified tag, regardless of the value of their `HandleVisibility` parameter, appear in the report.

Modifying Section Options

In a loop, a *section* refers to a space in the generated report in which information, including text, images, and tables, appears. You can alter the

appearance of sections in each loop appear in the report by using the options in the Figure Loop component's **Section Options** pane.

Create Section for Each Object in Loop. When you select this option, the loop automatically creates an individual section for each object found in the loop. It uses the object title as the section title. This option is useful when a loop does not contain a Chapter/Subsection component that organizes the loop results.

Display the Object Type in the Section Title. Enable this option by selecting **Create section for each object in loop**. It precedes section titles with object titles in the generated report.

- 1 Clear this option and generate the `figloop-tutorial` report.

The figures produced by the loop are:

```
Membrane Data
Invisible Membrane Data
An Application
An Invisible Application
```

- 2 Now select this option and regenerate the report.

The figures produced are now:

```
Figure - Membrane Data
Figure - Invisible Membrane Data
Figure - An Application
Figure - An Invisible Application
```

Create a Link Anchor for Each Object in Loop. Select this option to create a hyperlink to the object in the generated report.

Working with Property Table Components

In this section...

- “About Property Table Components” on page 5-9
- “Opening the Example Report Template” on page 5-11
- “Examining the Property Table Output” on page 5-11
- “Selecting Object Types” on page 5-12
- “Displaying Property Name/Property Value Pairs” on page 5-12
- “Editing Table Titles” on page 5-16
- “Entering Text into Table Cells” on page 5-16
- “Adding, Replacing, and Deleting Properties in Tables” on page 5-17
- “Displaying or Hiding Cell Borders” on page 5-18
- “Adding and Deleting Columns and Rows” on page 5-19
- “Resizing Columns” on page 5-19
- “Zooming and Scrolling” on page 5-19
- “Selecting Tables” on page 5-20

About Property Table Components

Property Table components display property name/property value pairs for objects in tables. This appears in the following example table from the `figloop-tutorial` report.

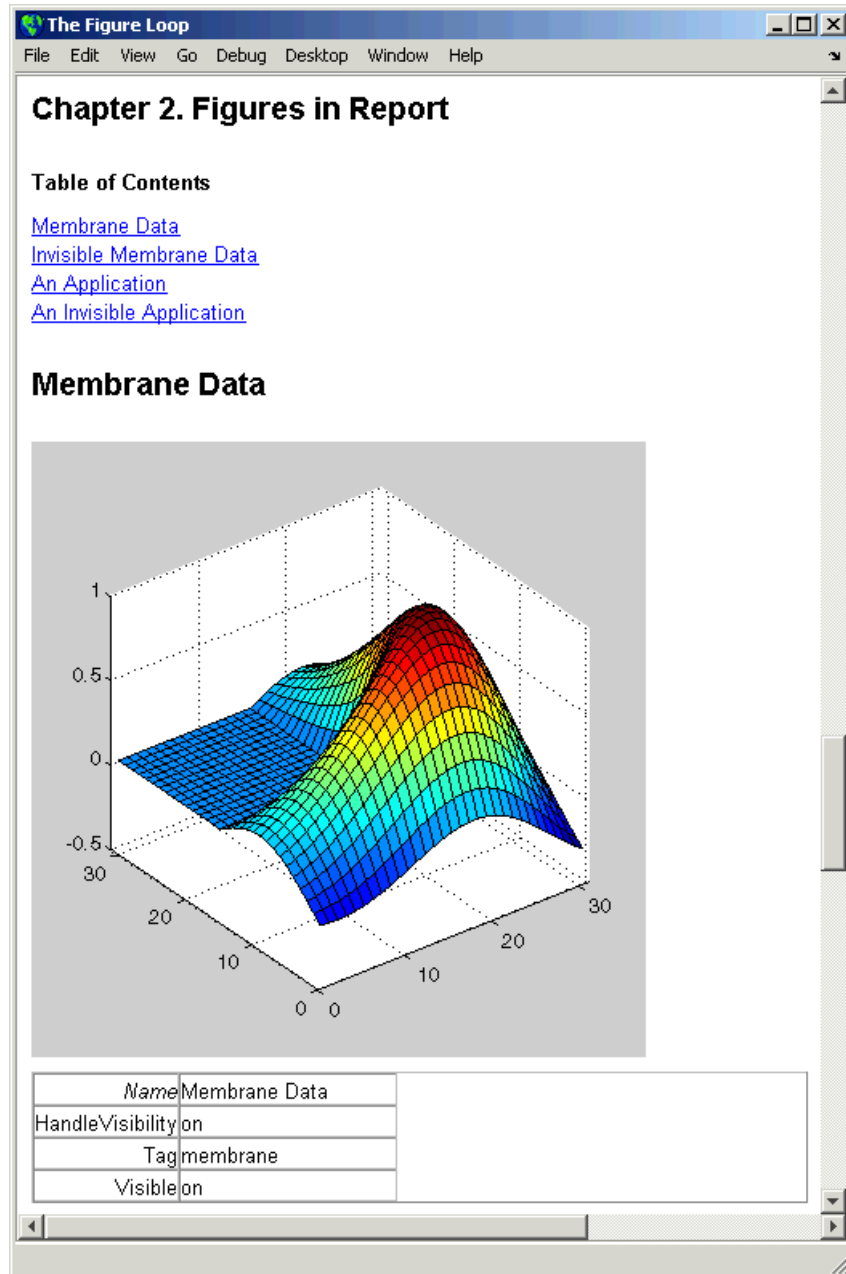

Many types of Property Table components are available, including:

- MATLAB Property Table
- Simulink Property Table
- Stateflow Property Table

The component used in this example represents MATLAB Report Generator Property Table components, all of which exhibit similar behavior.

Opening the Example Report Template

This example uses the `figloop-tutorial` report template. To open the figure loop tutorial report template, enter the following at the MATLAB command line:

```
setedit figloop-tutorial
```

Examining the Property Table Output

Property pages for all Property Table components are similar in form. The following figure shows the Properties pane for the Handle Graphics Property Table component. To modify table settings, click **Edit**.

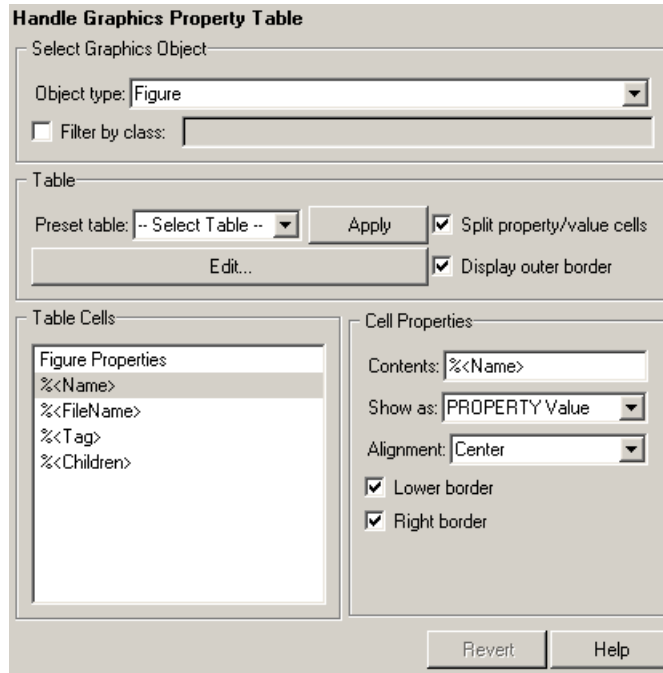

Selecting Object Types

Property Table components offer multiple object types on which to report. For example, the Handle Graphics Property table lets you report on a figure, an axes object, or a Handle Graphics object.

You can select a different object type on which to report in the **Object type** list in the component's Properties pane.

Displaying Property Name/Property Value Pairs

Split Property/Value Cells

In the Handle Graphics Property Table component's Properties pane, click **Edit**.

- 1 For a given property name and property value to appear together in one cell of a table, clear the **Split property/value cells** check box. The table is now in *nonsplit mode*. Nonsplit mode supports more than one property name/property value pair per cell and text.

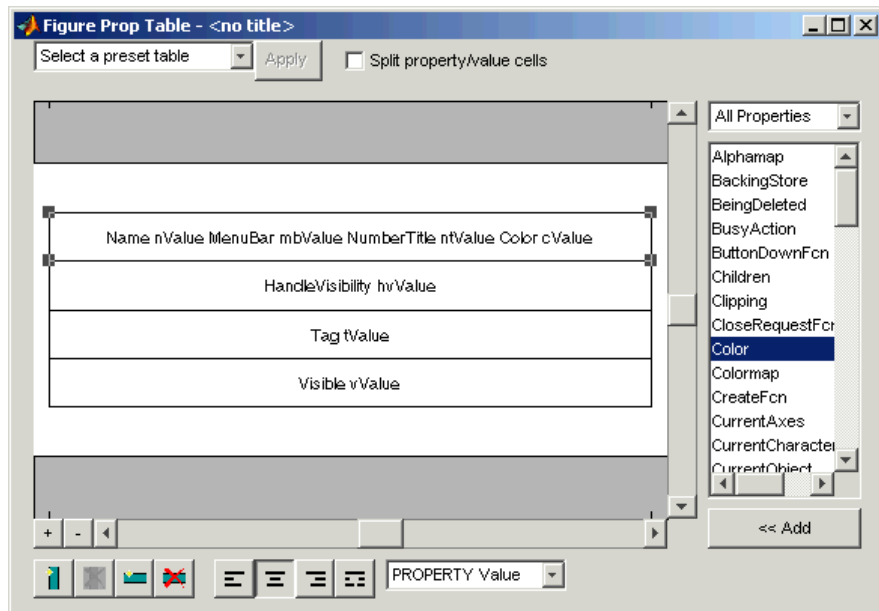

- 2 For the property name and property value to appear in adjacent horizontal cells in the table, select the **Split property/value cells** check box. The table is now in *split mode*. Split mode supports only one property name/property value pair per cell. If more than one property pair appears in a cell, only the first pair appears in the report; all subsequent pairs are ignored.

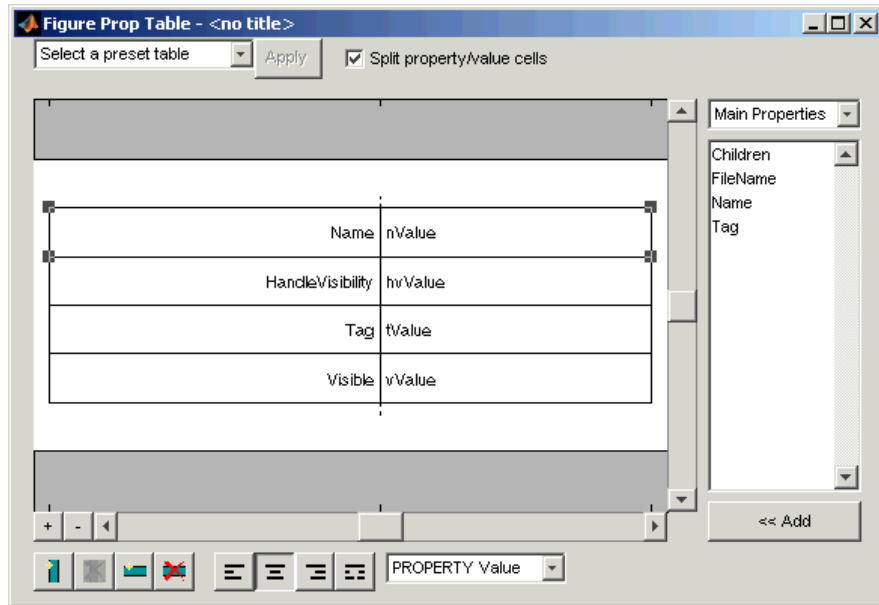

Display Options

Property name/property value pairs can appear in cells in several ways. To specify how a given property name/property value pair appears in a cell, select that field in the table and choose **Value** from the **Display As** selection list under the Figure Properties box. In the selected table row, only the value appears.

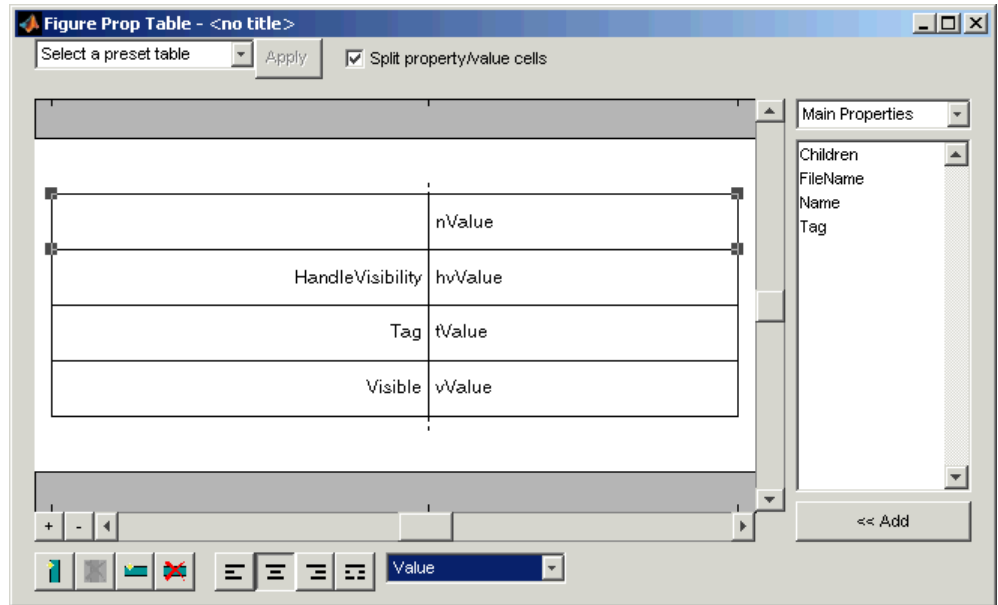

Formatting Options

To specify alignment for text in a given cell, use the four justification buttons in the toolbar under the Figure Properties box.

In this example, the selected table row is double justified. To change justification options, right-click a table row and make the changes in its context menu.

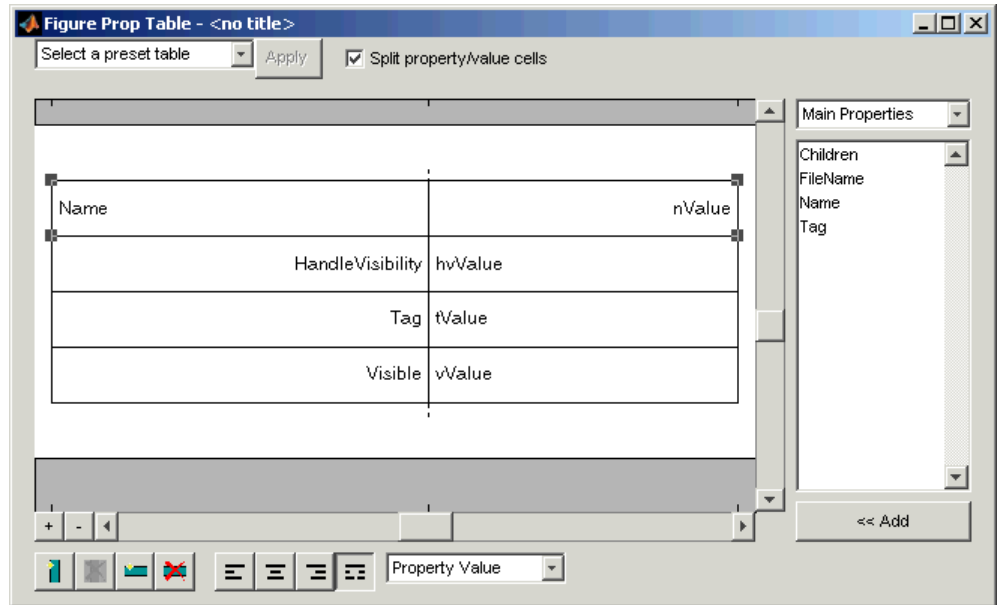

Editing Table Titles

Table titles can contain properties and text. By default, the title of a table is the same as the value of the %<Name> property. You can modify this property to modify the table title.

Note Table titles are always in nonsplit mode.

Entering Text into Table Cells

To enter text into a table cell, double-click the cell. A gray box appears with the label for the cell property.

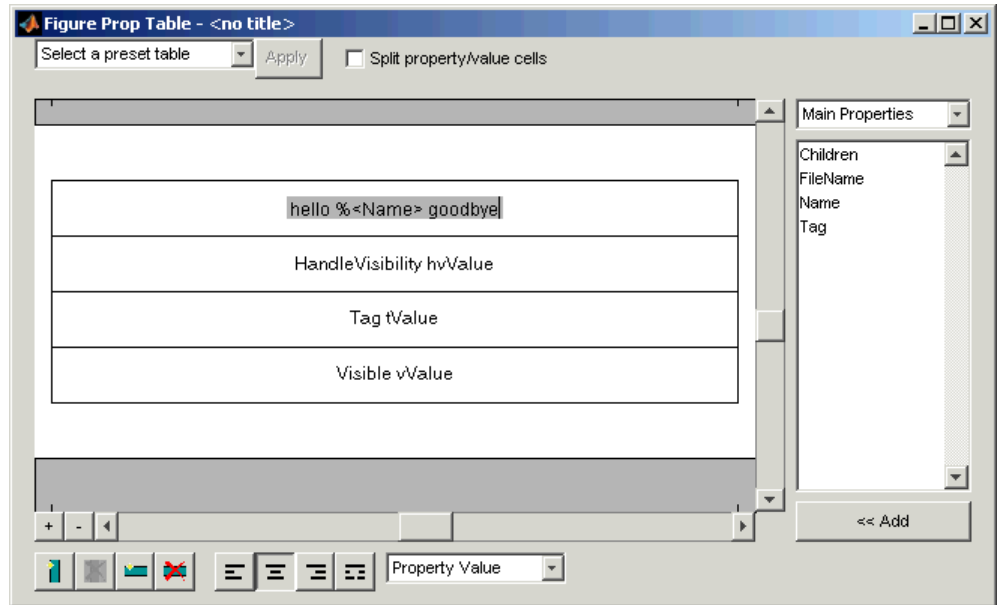

If you type text outside the angle brackets, the text appears as is in the report. Text inside the table brackets must specify a valid property name. If you enter an invalid property name, the property name appears in the report without a property value.

Note For the text to be visible, the table must be in nonsplit mode.

Adding, Replacing, and Deleting Properties in Tables

Adding Table Properties

To add a Handle Graphics property to a table cell:

- 1 In the Figure Prop Table window, add a new table row to the current table.
 - a Select a table row directly under the row to which to add a new property.
 - b Click **Add Row Above Current Cell**.

A new row appears above the current row.

- 2 Add the property to the new table row.
 - a Select the new table row.
 - b In the Properties Type selection menu at the upper-right of the window, select a property type.
 - c In the **Properties** menu, select the property you want to add.
 - d Click the << **Add** button, or double-click the property name. The property appears in the table row.

Alternatively, if you know the name of the property you want to add, enter the property name directly into the cell as described in “Entering Text into Table Cells” on page 5-16. For information about adding new table rows, see “Adding and Deleting Columns and Rows” on page 5-19.

Replacing Table Properties

To replace a property in a cell of a table in split mode, follow the instructions in “Adding Table Properties” on page 5-17.

Note You cannot use these steps to delete a property in a cell when the table is in nonsplit mode.

Deleting Table Properties

Delete a property by backspacing over it or using the **Delete** key.

Displaying or Hiding Cell Borders





To toggle cell borders on and off:

- 1 Place your cursor in a cell and right-click to invoke its context menu.
- 2 Choose **Cell borders > Top**, **Bottom**, **Right**, or **Left** to toggle the specified border on or off.

Adding and Deleting Columns and Rows

To add or delete a column or row, select a cell and then click one of the buttons described in the following table.

Note You cannot delete a row or column when it is the only row or column in the table.

Button	Action
	Add column (added to the left of the selected column)
	Delete selected column
	Add row (added above the selected row)
	Delete selected row



Resizing Columns

To resize the width of a column, click and drag its vertical borders as needed.

Zooming and Scrolling

Zooming

You can zoom in and out of the table with the zoom buttons, which are located to the left of the horizontal scroll bar.

Button	Action
	Zoom in
	Zoom out

Scrolling

You can scroll vertically and horizontally using the table's scroll bars.

Selecting Tables

To display property name/property value pairs, you can select a preset table or use a custom table.

- A preset table is built-in and formatted. You can select a preset table in the preset table selection list in the upper-left of the Figure Prop Table window. To apply a preset table, select the table and click **Apply**.
- To create a custom table, select a preset table and modify it to fit your needs by adding and/or deleting rows and properties. You may want to start with the **Blank 4x4** preset table.

Note You cannot save a custom table as a preset table. If you do so, you lose all changes to the custom table.

Working with Summary Table Components

In this section...
“About Summary Table Components” on page 5-21
“Opening the Example Report Template” on page 5-23
“Selecting Object Types” on page 5-23
“Adding and Removing Properties” on page 5-23
“Setting Relative Column Widths” on page 5-24
“Setting Object Row Options” on page 5-24

About Summary Table Components

Summary Table components insert tables that include specified properties for objects into generated reports. Tables contain one object per row, with each object property appearing in a column, as shown in the following Summary Table in the `figloop-tutorial` report.

Table 1.1. Figure Properties

Name	Tag	Visible	HandleVisibility
Membrane Data	membrane	on	on
Invisible Membrane Data	membrane	off	on
An Application	app	on	off
An Invisible Application	app	off	off
Peaks Data	peaks	on	on

Many types of Summary Table components are available, including:

- Handle Graphics Summary Table
- Simulink Summary Table
- Stateflow Summary Table

The component used in this example represents MATLAB Report Generator Summary Table components, all of which exhibit similar behavior

Opening the Example Report Template

This example uses the `figloop-tutorial` report template. To open the figure loop tutorial report template, enter the following at the MATLAB command line:

```
setedit figloop-tutorial
```

Selecting Object Types

You can use the **Object type** selection list to choose Handle Graphics object types for the Summary Table, including blocks, signals, systems, and models. The `figloop-tutorial` reports on figure objects.

Adding and Removing Properties

You can select object properties to appear in the Summary Table from the **Property Columns** pane. To add a property to the summary table, select the property category from the property category box to the right of the **Property columns** field. Selecting different property categories causes the selected category's properties to appear in the field under the box. The following figure shows `main` as the selected category.

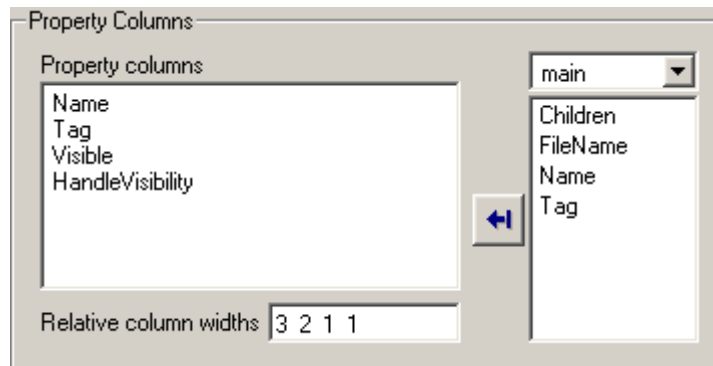

- To add a property:
 - 1** Select the category from the property category box.
 - 2** Select a property in the properties list.

- 3 Click the Add property  button.

The property appears in the **Property columns** field.

- To remove a property from the table:
 - 1 Select the property in the **Property columns** field.
 - 2 Press **Delete**.

The property name is removed from the **Property columns** field.

Note After making changes in the Report Explorer interface, click **Apply** to make the changes take effect.

You can define your own properties by entering their names into the **Property columns** field using valid variable notation. For more information, see “% Notation” on the Text component reference page in the MATLAB Report Generator documentation.

Setting Relative Column Widths

Use the **Width** field to apply a relative column width to the Summary Table columns in the generated report. If you do not specify a value for this field, column widths automatically set.

Setting Object Row Options

You can use the **Object Rows** pane to set options for table rows, including anchor, filtering, and sorting options. Select **Insert anchor for each row** to place an anchor in each table row in the report. Use the **Include figures** list to specify what objects to include in the Summary Table.

Summary Table components in `figloop-tutorial` report on figure objects. For more information on options for these figure objects, see the following sections:

- “Looping on the Current Figure” on page 5-6

- “Looping on Visible Figures” on page 5-7
- “Looping on Figures with Tags” on page 5-7

Comparing XML Files Exported from Simulink Models

- “How to Compare XML Files Exported from Simulink Models” on page 6-2
- “Using the XML Comparison Report” on page 6-8
- “Known Limitations and Workarounds” on page 6-14

How to Compare XML Files Exported from Simulink Models

In this section...

“Introduction” on page 6-2

“Overview of XML Comparison” on page 6-3

“Enabling XML Comparison” on page 6-4

“Selecting Files to Compare” on page 6-4

“Demos of XML Comparison” on page 6-6

“See Also” on page 6-7

Introduction

You can use Simulink Report Generator software to compare XML text files exported from Simulink models.

You can select a pair of Simulink models to compare their XML files. The XML comparison tool first exports the models to XML, using the 'ExportToXML' option of the Simulink `save_system` function. The XML comparison tool compares the resulting XML files and processes the results into a report. You can use the report to explore the differences and view the changes highlighted in the original models.

You can access the XML comparison tool from:

- The MATLAB Current Directory browser context menu
- The MATLAB File and Directory Comparisons Tool
- The MATLAB command line.
- The Simulink Model Editor **Tools** menu

The XML comparison tool compares the XML files using the “Chawathe” algorithm, as described in the paper:

Change Detection in Hierarchically Structured Information, Sudarshan Chawathe, Anand Rajaraman, and Jennifer Widom; SIGMOD Conference, Montreal, Canada, June 1996, pp. 493-504.

This conference paper is based upon work published in 1995: see <http://dbpubs.stanford.edu:8090/pub/1995-45>.

The Simulink Report Generator XML comparison functionality is an extension of the MATLAB Report Generator XML comparison feature. See “Comparing XML Files” in the MATLAB Report Generator documentation.

Overview of XML Comparison

After you register XML comparison, XML comparison reports display in the File and Directory Comparisons Tool. To register, see “Enabling XML Comparison” on page 6-4. For more information about the File and Directory Comparisons Tool, see “Comparing Files and Directories” in the MATLAB Desktop Tools and Development Environment documentation.

The comparison tool processes the output of the XML comparison into an interactive HTML report with hyperlinks that you can click to reverse annotate from the XML tag comparison to the corresponding Simulink models. “Reverse annotation” means when you click items in the HTML report, Simulink Report Generator displays the corresponding items highlighted in the original models.

The XML comparison report shows a hierarchical view of the portions of the two XML files that differ. The report does not show sections of the files that are identical.

If the files are identical you see a message reporting there are no differences.

Note It might not be possible for the analysis to detect matches between previously corresponding sections of files that have diverged too much.

Change detection in the Chawathe analysis is based on a scoring algorithm. Items match if their Chawathe score is above a threshold. The Simulink Report Generator implementation of Chawathe’s algorithm uses a comparison

pattern that defines the thresholds assigned to particular node types (e.g., “block”). For more information, see “How The Matching Algorithm Works” in the MATLAB Report Generator documentation.

For more information on the display of special cases, see “Understanding the Report” on page 6-12.

Enabling XML Comparison

If you have Simulink Report Generator software, you automatically enable (or “register”) XML comparison when you load Simulink software.

If you have not loaded Simulink software, then you can enable XML comparison by entering this command at the MATLAB command line:

```
slxmlcomp.register
```

The XML comparison tool is a registered extension of the File and Directory Comparison Tool’s integration with the Current Directory browser. Once registered, you can launch the XML comparison tool directly from the Current Directory browser.

To automatically enable XML comparison when you start a MATLAB session, add the register command to a `startup.m` file. Alternatively, you could create a MATLAB shortcut for the register command to access from your toolbar and Start menu.

Selecting Files to Compare

- “From the Simulink Editor” on page 6-4
- “From the Current Directory Browser” on page 6-5
- “From the File and Directory Comparisons Tool” on page 6-6
- “From the Command Line” on page 6-6

From the Simulink Editor

To compare files using the Simulink Editor:

1 Select Tools > Compare Simulink XML Files.

The Compare Simulink XML Files dialog box opens.

2 If the Editor currently displays a model, the current model name and path appear automatically selected in the **Left model file** edit box. Use the browse buttons to locate and select files for the left and right model files.

3 When you click **OK**,

- a** The XML comparison tool loads the first model file, exports it to an XML file in `tempdir`, and closes the model (unless you already had the model open).
- b** The XML comparison tool loads the second model file, exports it to an XML file in `tempdir`, and closes the model (unless you already had the model open).
- c** The XML comparison tool performs the Chawathe analysis on the exported XML text files.
- d** The resulting report displays in the File and Directory Comparisons window.

See also “Saving Comparison Files in a Zip File” on page 6-13.

From the Current Directory Browser

To compare two files in the same directory:

- 1** From the Current Directory browser, select the files or directories you want to compare.
- 2** Right-click, and from the context menu, select **Compare Selected Files**.

If the selected files are XML files, the XML text comparison tool performs a Chawathe analysis and displays an HTML report in the File and Directory Comparisons window. If the selected files are `.mdl` files, the XML comparison tool first exports the `.mdl` files to XML files, and then performs the Chawathe analysis on the exported XML text files and produces the report.

The file you right-click to launch the XML comparison tool displays on the right side of the report.

For more information about comparisons of other file types (e.g., text, MAT or binary) with the File and Directory Comparisons Tool, see “Comparing Files and Directories” in the MATLAB Desktop Tools and Development Environment documentation.

To compare files in different directories, you can use the File and Directory Comparisons Tool, the Simulink Editor, or command-line access methods.

From the File and Directory Comparisons Tool

To compare files using the File and Directory Comparisons Tool, launch the tool from the **MATLAB Desktop** menu.

If the files you select to compare are XML files or files with the .mdl file extension, the tool performs a Chawathe analysis. In the case of .mdl files, the XML comparison tool first exports the .mdl files to XML files, performs a Chawathe analysis, and then produces an HTML report.

From the Command Line

To compare XML files from the command line, enter:

```
visdiff(filename1, filename2)
```

Where `filename1` and `filename2` are XML files or Simulink models. If they are models, the XML comparison tool performs the comparison on the exported XML files. This XML comparison functionality is an extension to the MATLAB `visdiff` function.

If you want the MATLAB differences report for XML or model files, you can still do this at the command line as follows:

```
xmlcomp.textCompare(filename1, filename2)
```

Demos of XML Comparison

For examples with instructions, see the following demos:

- `slxml_sfcar`

- `s1xml_truthtables`

See Also

For explanations on how to use and understand the report and the XML comparison functionality, refer to:

- “Using the XML Comparison Report” on page 6-8
- “Known Limitations and Workarounds” on page 6-14

Using the XML Comparison Report

In this section...
“Navigating the Simulink XML Comparison Report” on page 6-8
“Displaying Items in Original Models” on page 6-10
“Understanding the Report” on page 6-12
“Saving Comparison Files in a Zip File” on page 6-13

Navigating the Simulink XML Comparison Report



The XML Comparison report shows changes only, not the entire XML text file contents. The report shows a hierarchical view of the portions of the two XML files that differ. The report does not show sections of the files that are identical.



Click to select items in the hierarchical trees and observe the following display features:

- Selected items appear highlighted in **bold**.
- If the selected item is part of a matched pair it appears highlighted in **bold** in both left and right trees.
- When you select an item, the original model displays and the corresponding item is highlighted. See “Displaying Items in Original Models” on page 6-10.

Note Hierarchical node tags can appear multiple times in the tree as nested nodes. See “Understanding the Report” on page 6-12.

Hover the mouse cursor over icons to see descriptive tooltips. Icons indicate:

- The nature of the difference:
 -  Modified.
 -  Moved.

-  Unmatched (items found only on one side).
 -  Reordered. This means items at the same level in the XML hierarchy have changed order. This change has no effect on the behavior of the original models.
 -  Cosmetic change, i.e., nonfunctional differences between the files, such as properties like position or color. See “Cosmetic Changes” on page 6-12.
- The other icons indicate the category of item, for example: model, subsystem, Stateflow machine or chart, block, line, parameter, etc.

Use the buttons at the top of the report for the following functions:

- **Legend** — Displays the Legend window with definitions of the report icons.
- **Show Cosmetic** or **Hide Cosmetic** — Toggle display of cosmetic changes in the report.

Cosmetic changes are nonfunctional differences between the files, such as repositioning of items. By default the report hides all cosmetic changes. You can explore *all* differences including cosmetic changes by clicking **Show Cosmetic**. The button toggles to **Hide Cosmetic**. Click **Hide Cosmetic** to remove the display of cosmetic items. See “Cosmetic Changes” on page 6-12.

- **Redraw** — Redraws the report. This does *not* run the Chawathe analysis again.

To run the analysis again, click the **Refresh** button at the top of the File and Directory Comparisons window.

- **Printable Report** — Opens the Export Printable Report dialog box, where you can select a file name and location to save the report. The report is a noninteractive HTML document of the differences detected by the Chawathe algorithm for printing or archiving a record of the comparison.
- **Expand All** — Expands every item in both of the trees.
- **Collapse All** — Collapses all items in both of the trees to the most compact view possible.

- **Disable/Enable Highlighting** — Toggles reverse annotation on and off. See “Displaying Items in Original Models” on page 6-10.

For examples with instructions, see also “Demos of XML Comparison” on page 6-6 .

Displaying Items in Original Models

When you compare the XML text files exported from Simulink models, you can click report items to display the corresponding items in the original models. You can use this *reverse annotation* function to explore the changes in the original models. When you select an item, the HTML hyperlink invokes reverse annotation to the original model and highlights the corresponding item in the model.

Click a report entry to view the highlighted item (or its parent) in the model:

- If the item occurs in both models, they both appear with highlighting.
- If there is no match for the item, the unmatched icon () is present. It is considered unique and appears highlighted by itself. An appropriate system in the other model also displays to show the context of the missing item.
- If the XML comparison tool cannot highlight an item directly (e.g., configuration parameters), then it highlights the nearest ancestor of the selected node.
- To maximize screen space the models display with the status bar, menu bar, and model browser turned off.

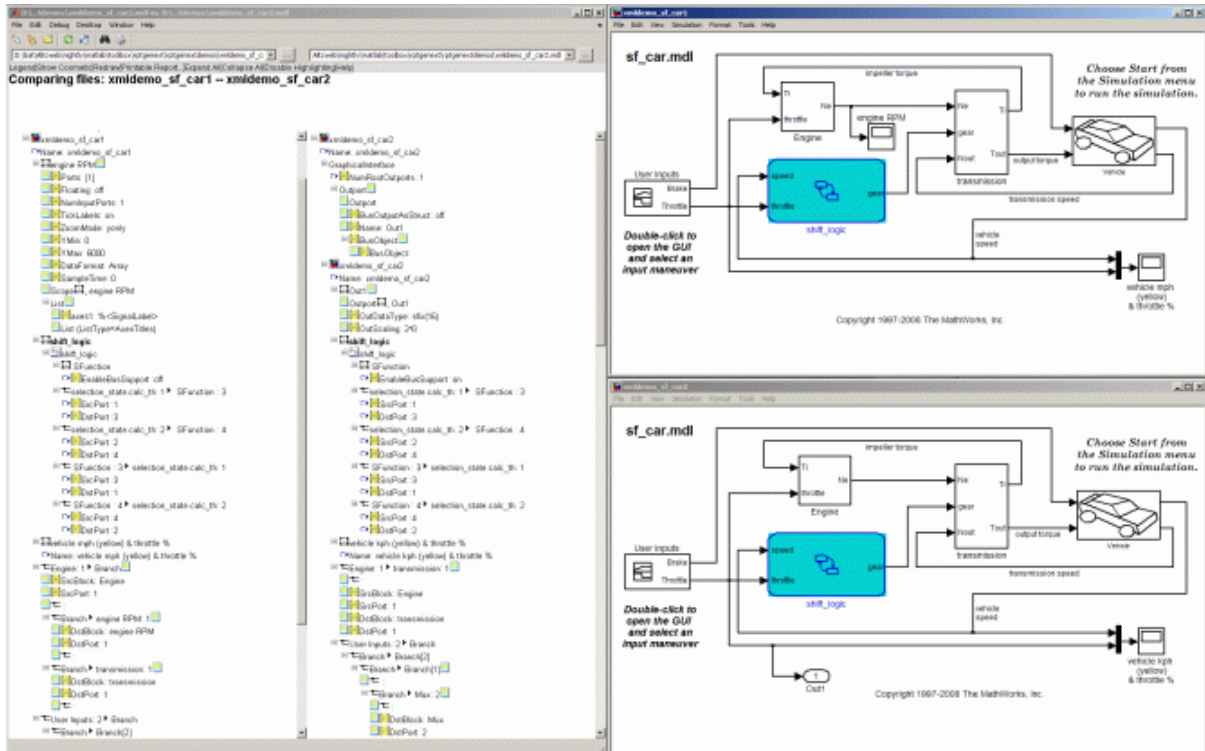

Controlling Reverse Annotation

You can toggle reverse annotation on and off by clicking the **Disable/Enable Highlighting** button in the File and Directory Comparison Tool.

By default, models display to the right of the comparison report. If you move or resize the models your position settings are respected by subsequent reverse annotation operations within the same session. The tool remembers your window positions.

If you want to preserve window positions across sessions, position the window, and then enter:

```
slxmlcomp.storeWindowPositions
```

This preserves the placement of any Simulink windows, Stateflow windows, and truth table windows.

To stop storing window positions and return to the defaults, enter:

```
slxmlcomp.clearWindowPositions
```

Understanding the Report

To understand the report, it is helpful to understand how the Chawathe results from the exported XML text files relate to the original models. Some special features of the report include:

- Hierarchical node tags (such as subsystem tags in the .xml file) appear twice in the tree as nested nodes. This is because the container node and the contents can have separate differences in their properties.

This feature of the XML report allows you to distinguish between property differences of the node itself, and differences contained within nodes nested inside.

To see an example of nested nodes for a Stateflow block and its Stateflow chart, see the `slxml_sfcar` demo.

- Simulink software adds new parameters when the value of that parameter differs from the default, for example, rotating a block adds a new "rotated" parameter.
- If the original models contain Embedded MATLAB™ components or truth tables, and if differences are found, the XML comparison tool lists them in the Stateflow section of the report. Click the **New report** icon to open a new tab in the File and Directory Comparison window, showing a MATLAB difference report for the Embedded MATLAB components or truth tables.

For more information, see “How The Matching Algorithm Works” in the MATLAB Report Generator documentation.

See also “Known Limitations and Workarounds” on page 6-14.

Cosmetic Changes

You can use the **Show/Hide Cosmetic** button to toggle display of cosmetic changes. Hiding cosmetic changes allows you to view the report with only

functional changes displayed. Use **Show Cosmetic** to view *all* identified changes.

The report processing identifies certain items in the XML file as cosmetic, for example, tags representing parameters such as block, system, chart or label positions, font and color settings for blocks and lines, and system print and display settings.

The report adds the cosmetic icon to identify cosmetic items ().

The report processing tries to identify “consequential” changes as cosmetic (that is, changes as a consequence of another change). For example, if a block name changes from `block_A` to `block_B`, a line emerging from that block has a change in its source block parameter. This change in the line parameters is considered cosmetic.

Exceptions. The report displays changes to Block and System names, annotations, and Stateflow Notes as noncosmetic, even though changes to these items do not affect the outcome of simulation. The report always displays these changes to facilitate review of code changes, as they can contain important information about users’ intentions.

Saving Comparison Files in a Zip File

Temporary comparison files accumulate in `tempdir`, in subfolders with names starting with `mwxml`.

To zip the temporary files (such as log files) created during XML text comparisons for sharing or archiving, enter:

```
xmlcomp.zipTempFiles('c:\work\myexportdirectory')
```

The destination directory must exist. The output reports the zip file name:

```
Created the zipfile "c:\work\myexportdirectory\20080915T065514w.zip"
```

To view the log file for the last comparison in the MATLAB Editor, enter:

```
xmlcomp.showLogFile
```

Known Limitations and Workarounds

In this section...
“Unexpected Results” on page 6-14
“Setting File and Memory Sizes” on page 6-15
“Comparing XML Files from Models with Identical Names” on page 6-15
“Cannot Export XML Text Files from Unsaved Models” on page 6-16
“Errors from UNC Paths” on page 6-17
“Resolving Cosmetic Issues with the HTML Browser” on page 6-17

Unexpected Results

If you see a MATLAB differences report when you expected to see an XML comparison report, check that you enabled the XML functionality with the `register` command. See “Enabling XML Comparison” on page 6-4.

If you see unexpected results within an XML comparison report, see “How The Matching Algorithm Works” in the MATLAB Report Generator documentation.

Note It might not be possible for the analysis to detect matches between previously corresponding sections of files that have diverged too much.

If you cannot see changes you expected to see in the report, remember that changes the tool identifies as “cosmetic “ are hidden by default. Click the **Show cosmetic** button to see *all* identified changes. See “Cosmetic Changes” on page 6-12.

The **Find** tool in the File and Directory Comparisons toolbar only searches visible report items. To search the entire report, click **Expand All** before searching.

Setting File and Memory Sizes

You can use the following command line options to manage browser file size and JVM memory.

These options are persistent across sessions.

First create an `xmlcomp.options` object:

```
obj = xmlcomp.options
```

You might need to increase the MATLAB browser's file size limit to display some comparisons. For example, to increase the limit in bytes for the size of file that you can display in the browser (from the default 7e6), enter:

```
obj.setMaxBrowserFileSize(7e7)
```

To reset the amount of memory in megabytes (MB) available to the external JVM process used for comparisons (the default is 1024 MB), enter:

```
obj.setJVMMemLimit(2048)
```

To restore factory values, use

```
obj.reset
```

Comparing XML Files from Models with Identical Names

You can compare XML text from files of the same name. To complete the operation, the XML comparison tool copies the models to a temporary directory. Temporary comparison files accumulate in `tempdir`, in subfolders with names starting with `mwxml`. The XML comparison tool gives copies of the models unique names, exports XML files, and compares them. Note that the names are reported as changes because of this process of applying unique names.

Warning When you use reverse annotation from the report, the models that display are temporary copies with new names. Any changes you make are to those temporary copies, and so probably will be lost.

You must close open models before the XML comparison tool can export two models with the same name to XML. If one of the models is open when you try to export it to XML, a dialog box appears where you can click **Yes** to close the file and proceed, or **No** to abort.

If you want to automatically close open models of the same name when exporting to XML and not see the dialog box again, run these commands:

```
opt = slxmlcomp.options
opt.setCloseSameNameModel(true)
```

This is persistent across MATLAB sessions. To revert to default behavior and be prompted whether or not to close the open model every time, enter:

```
opt = slxmlcomp.options
opt.setCloseSameNameModel(false)
```

The problem requiring you to close the loaded model is called “shadowed files”. In some cases, another model with the same name might be in memory, but not visible. See “Shadowed Files” in the Simulink documentation for more information.

Alternatively, you can run the comparison by renaming or copying one of the files.

Note Model name changes are reported as changes, due to the temporary models

Cannot Export XML Text Files from Unsaved Models

You cannot export XML text files from modified models without saving the models first. If you try, you see errors. Save modified models before running an XML comparison.

Similarly, you cannot compare the XML files exported from newly created models without saving the models first. If you try, you see errors. Save new models before running an XML comparison.

Errors from UNC Paths

On a Windows platform, you should not start a MATLAB session, from a Universal Naming Convention (UNC) path, such as \\mycompany\bigserver\matlab. You will see errors if you do this. UNC paths are not supported for *matlabroot*.

You can work around this by mapping a drive to the location.

Resolving Cosmetic Issues with the HTML Browser

You might see rendering problems for certain sizes of window, due to issues with the version of ICE browser that ships with MATLAB software. Try the **Redraw** button if you see missing or extra scroll bars. Next, try undocking the comparison window if you see double scroll bars.

Component Reference

Real-Time Workshop Components (p. 7-2)	Report on code generated by Real-Time Workshop software
Requirements Management Interface Components (p. 7-3)	Report block requirements data
Simulink Components (p. 7-4)	Report on Simulink models
Simulink Blocks Components (p. 7-7)	Report on specified Simulink block types
Simulink® Fixed Point Components (p. 7-8)	Report on Simulink® Fixed Point™ blocks
Stateflow Components (p. 7-9)	Report on Stateflow models

This chapter describes Simulink Report Generator components. For information about MATLAB Report Generator components, see “Component Reference” in the MATLAB Report Generator documentation.

Real-Time Workshop Components

Code Generation Summary

Insert version number information, list of generated files, tables summarizing code generation configuration information, and subsystem maps into report

Import Generated Code

Import source and header files generated by Real-Time Workshop software, and custom files specified as part of model

Requirements Management Interface Components

Requirement Block Loop	Apply child components to blocks with requirements
Requirement System Loop	Apply child components to systems with requirements
Requirements Summary Table	Display properties of blocks, systems, or Stateflow objects with associated requirements
Requirements Table	Create table with requirements information from Simulink [®] Verification and Validation [™] software

Simulink Components

Simulink components have the following relationships.

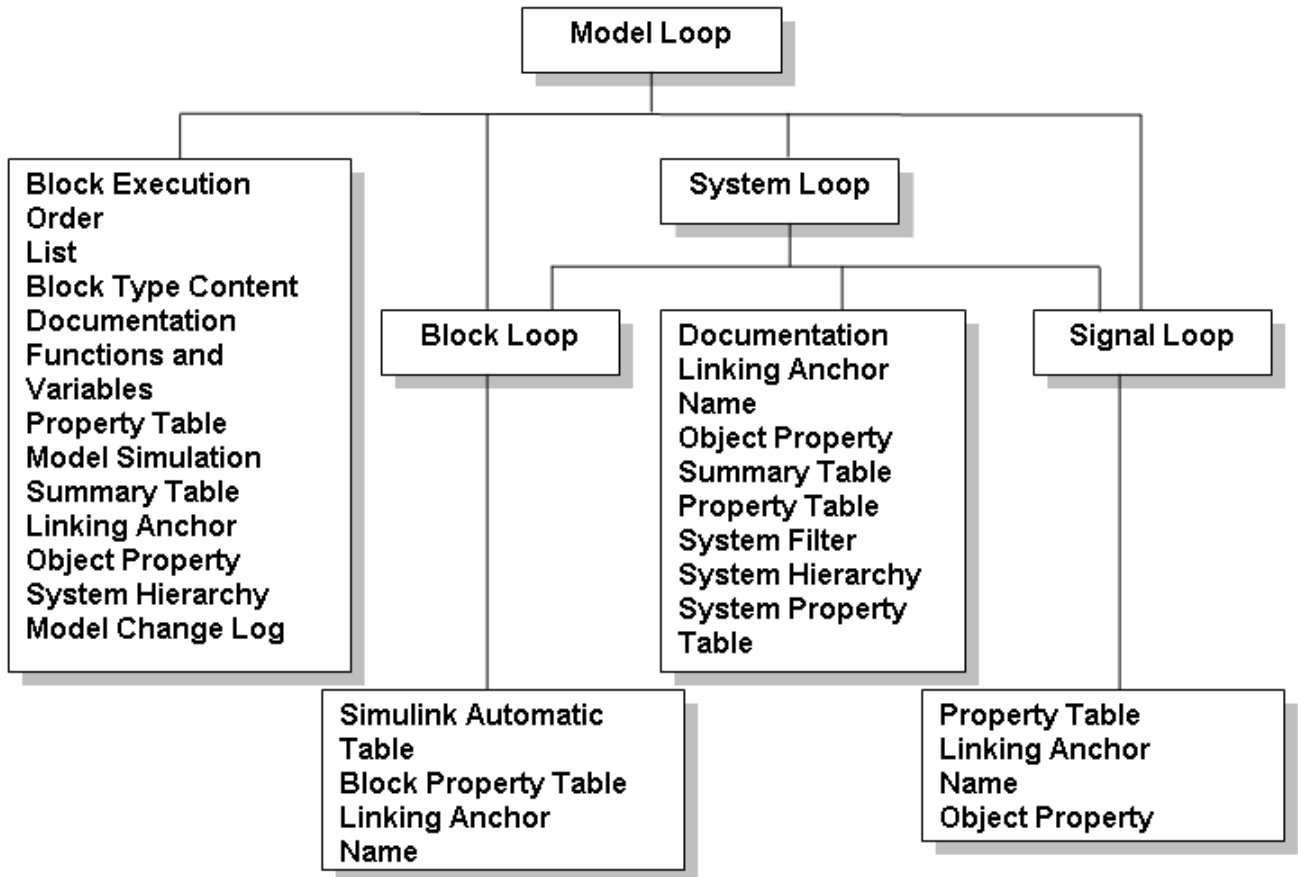

Annotation Loop

Run child components multiple times for each Simulink annotation in current context

Block Execution Order List

Create a list or table of all nonvirtual blocks in the model, showing order in which they execute

Block Loop	Run child components for each block contained in the current system, model, or signal
Block Type Count	Count number of each block type in the current model or system
Model Advisor Report	Insert Model Advisor report or link to Model Advisor report for current model
Model Change Log	Construct model history table that displays model revision information
Model Loop	Loop on Simulink models and systems, as specified by child components
Model Simulation	Run current model with specified simulation parameters
Signal Loop	Run child components for each signal contained in current system, model, or block
Simulink Automatic Table	Insert two-column table with information on selected model, system, signal, or block
Simulink Dialog Snapshot	Insert snapshots of Simulink editor dialog boxes
Simulink Functions and Variables	Create table that displays workspace variables and MATLAB functions used by reported blocks in Simulink models
Simulink Library Information	Insert table that lists library links in the current model, system, or block
Simulink Linking Anchor	Designate locations to which links point
Simulink Name	Insert name of a Simulink model, system, block, or signal into report

Simulink Property	Insert property name/property value pair for current Simulink model, system, block, or signal
Simulink Property Table	Insert table that reports on model-level property name/property value pairs
Simulink Sample Time	Insert title of Simulink sample time into report
Simulink Summary Table	Display properties or parameters of specified Simulink models, systems, blocks, or signals in table
System Filter	Run child components only if the current system meets specified conditions
System Hierarchy	Create nested list that shows hierarchy of specified system
System Loop	Specify systems and subsystems on which to loop, as defined by parent component
System Snapshot	Insert snapshot of the current system into report
To Workspace Plot	Capture plot figure created in the MATLAB workspace

Simulink Blocks Components

Bus	Create list of signals exiting from Bus Selector block
Documentation	Insert text extracted from DocBlock blocks in Simulink models
Look-Up Table	Report on lookup table blocks
Scope Snapshot	Insert images of Simulink scopes and XY graphs

Simulink Fixed Point Components

Simulink Fixed Point components have the following relationships.

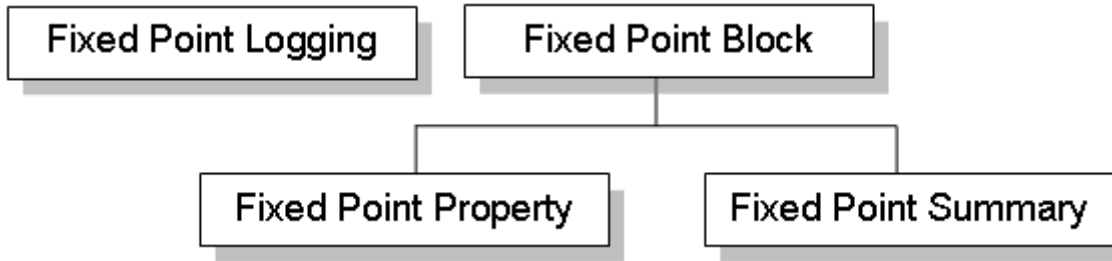

Fixed Point Block Loop

Run child components for the Simulink model, system, or signal defined by parent component

Fixed Point Logging Options

Set fixed-point options like in Fixed Point Tool

Fixed Point Property Table

Insert table that reports on Simulink Fixed Point block property name/property value pairs

Fixed Point Summary Table

Display table of specified fixed-point block properties or parameters

Stateflow Components

Stateflow components have the following relationships.

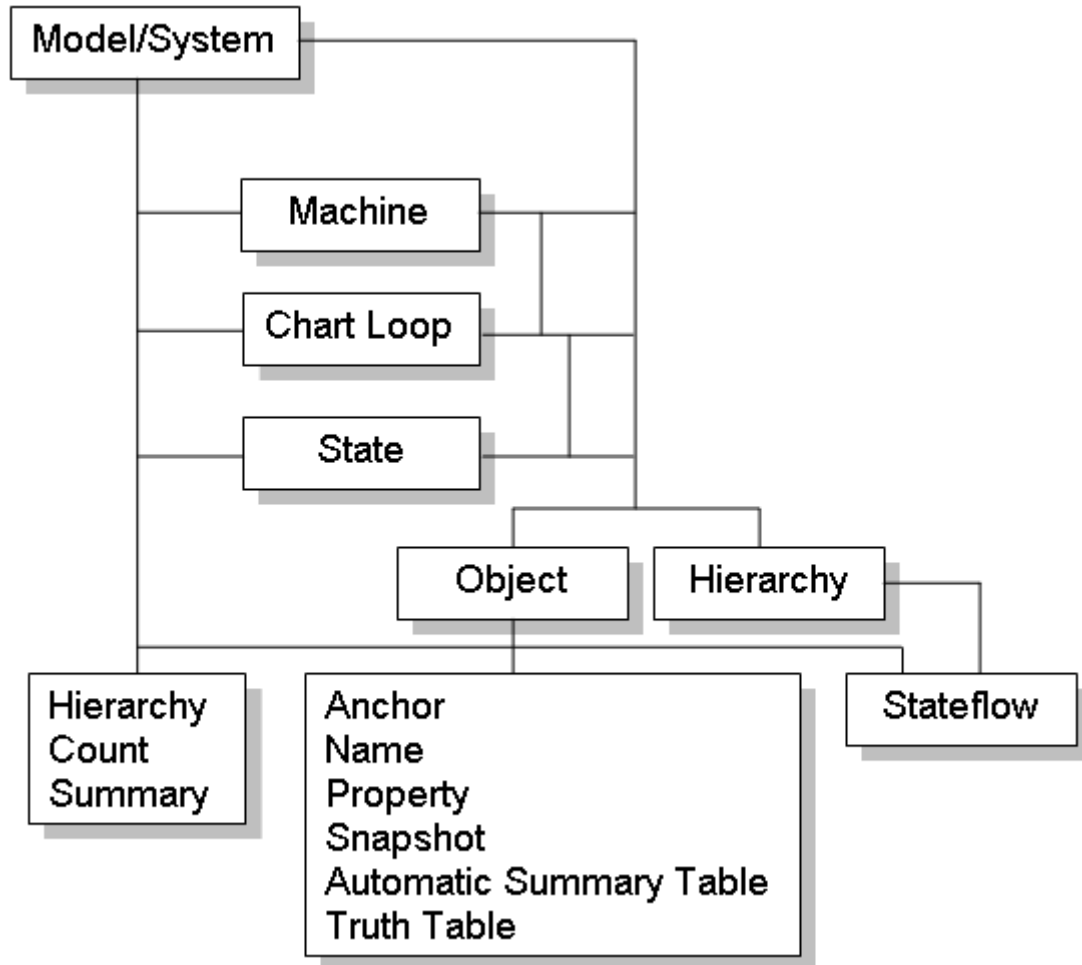

Chart Loop	Run child components for specified Stateflow charts
Machine Loop	Run child components for specified Stateflow machines
Object Loop	Run child components for Stateflow objects, and then insert table into report
State Loop	Run child components for all states in current context
Stateflow Automatic Table	Insert table with properties of current Stateflow object
Stateflow Count	Count number of Stateflow objects in current context
Stateflow Dialog Snapshot	Insert snapshots of Stateflow editor dialog boxes
Stateflow Filter	Run child components only if current object type matches specified object type
Stateflow Hierarchy	Provide visual representation of the hierarchy of a Stateflow object
Stateflow Hierarchy Loop	Run child components on Stateflow object hierarchy
Stateflow Linking Anchor	Designate locations to which links point
Stateflow Name	Insert into report name of Stateflow object specified by parent component
Stateflow Property	Insert into report table, text, or paragraph with information on selected Stateflow object property
Stateflow Property Table	Insert into report property-value table for Stateflow object
Stateflow Snapshot	Insert into report snapshot of Stateflow object

Stateflow Summary Table	Display table of properties or parameters of specified Stateflow object
Truth Table	Report on truth tables in Simulink and Stateflow models

Components: Alphabetical List

For a list of MATLAB Report Generator components, see MATLAB Components – Alphabetical List in the MATLAB Report Generator documentation.

Annotation Loop

Purpose Run child components multiple times for each Simulink annotation in current context

Description This component runs its child components multiple times for each Simulink annotation in the current context. The parent component determines the context. Options include:

- **Model Loop:** Reports on all annotations inside the reported portion of the reported model.
- **System Loop:** Reports on all annotations inside the current system.
- **Block Loop or Signal Loop:** Does nothing.

Loop Options The Loop Options pane displays information about the current context. You can sort `Alphabetically` by `text` or `In traversal order`.

Child components of the `Annotation Loop` consider their context to be annotations when the report is running.

For example, the following components report on the looped annotation:

- `Simulink Automatic Table`
- `Simulink Linking Anchor`
- `Simulink Name`
- `Simulink Property`
- `Simulink Property Table`

Use a `Summary Table` component to show annotation objects in reports. Each `Summary Table` component creates a single table with each reported annotation on a single row of the table.

Section Options

- **Create section for each object in loop:** Inserts a section in the generated report for each object found in the loop.
- **Display the object type in the section title:** Inserts the object type automatically into the section title in the generated report.

- **Create link anchor for each object in loop:** Creates a hyperlink to each object in the loop, the generated report.

See Also

Block Loop, Model Loop, Signal Loop, System Loop, Simulink Linking Anchor, Simulink Name, Simulink Property, Simulink Property Table, Simulink Summary Table

Block Execution Order List

Purpose	Create a list or table of all nonvirtual blocks in the model, showing order in which they execute
Description	<p>This component creates a list or table of all nonvirtual blocks in the model, showing the order in which they execute.</p> <p>For more information about virtual and nonvirtual blocks, see “About Blocks” in the Simulink documentation.</p>
Properties	<ul style="list-style-type: none">• List Title:<ul style="list-style-type: none">▪ Automatic: Generates a list or table title automatically.▪ Custom: Enables you to enter a title.• Include block type information: Include each block’s BlockType property in the list or table.• Look under nonvirtual subsystems: The default is Automatic (On for models, Off for systems). Set it to On or Off.
Insert Anything into Report?	Yes. List.
File Name	rptgen_sl.csl_blk_sort_list
See Also	Block Loop

- Purpose** Run child components for each block contained in the current system, model, or signal
- Description** This component runs its child components for each block contained in the current system, model, or signal.
- For more information on working with looping components, see “Working with Looping Components” on page 5-3.
- Report On** This pane describes the type of object on which this component operates.
- **Automatic list from context:** Report on all blocks in the current context. The Block Loop component’s parent component determines its context. If this component does not have the Model Loop, System Loop, Signal Loop, or Block Loop as its parent, selecting this option causes this component to report on all blocks in all models.
- Options include:
- Model Loop: Reports on all blocks in the current model.
 - System Loop: Reports on all blocks in the current system.
 - Signal Loop: Reports on all blocks connected to the current signal.
- **Custom - use block list:** Enables you to specify a list of blocks on which to report. Enter the full path of each block.

Loop Options

Choose block sorting options and reporting options in this pane.

- **Sort blocks**

Use this option to select how to sort blocks:

- Alphabetically by block name. Sorts blocks alphabetically by their names.
- Alphabetically by system name. Sorts systems alphabetically. Blocks in each system are listed, but in no particular order.

Block Loop

- Alphabetically by full Simulink path. Sorts blocks alphabetically by Simulink path.
- By block type. Sorts blocks alphabetically by block type.
- By block depth. Sorts blocks by their depth in the model.
- By traversal order. Sorts blocks by traversal order.
- By simulation order. Sorts blocks by execution order.
- %<VariableName>: Inserts the value of a variable from the MATLAB workspace. The %<> notation can denote a string or cell array. The following example reports on the `theta dot` integrator block and the `theta` integrator block in the demo model `simpend`, using the variable `Z={ 'simpend/theta' }`:

```
simpend/theta dot
%<Z>
```

The generated report includes information about the following blocks:

- `simpend/theta dot`
- `simpend/theta`

For more information, see %<VariableName> Notation on the Text component reference page in the MATLAB Report Generator documentation.

If you do not select this option, blocks are reported on in the order in which they are listed in the block list.

- **Search for Simulink property name/property value pairs:** Reports only on Simulink blocks with specified property name/property value pairs.
- **Create section for each object in loop:** Inserts a section in the generated report for each block found in the loop.
- **Display the object type in the section title:** Automatically inserts the object type into the section title in the generated report.

Section Options

- **Create link anchor for each object in loop:** Create a hyperlink to the block in the generated report.

Insert Anything into Report?

Yes, inserts a section if you select the **Create section for each object in loop** option.

File Name

rptgen_sl.csl_blk_loop

See Also

Model Loop, Signal Loop, System Loop, Simulink Linking Anchor, Simulink Name, Simulink Property, Simulink Property Table, Simulink Summary Table

Block Type Count

Purpose	Count number of each block type in the current model or system
Description	<p>This component counts the number of each block type in the current model or system. Within a model, this component counts blocks underneath masks and inside library links.</p> <p>For more information about block types, see “About Blocks” in the Simulink documentation.</p>
Count Types	<p>Where block types are counted depends on this component’s parent:</p> <ul style="list-style-type: none">• Model Loop: Reports all block types in the current model:<ul style="list-style-type: none">▪ All blocks in model: Counts block types in the entire model.▪ All blocks in reported systems: Counts block types only in systems that appear in the report.• System Loop: Reports all block types in the current system.
Table Content	<ul style="list-style-type: none">• Table title: Allows you to enter the table title.• Show block names in table: Includes a column that displays all block names in the table.• Sort table:<ul style="list-style-type: none">▪ Alphabetically by block type: Sorts blocks alphabetically by block type.▪ By number of blocks: Sorts by decreasing number of occurrences.• Show total count: Displays total number of block types.
Insert Anything into Report?	Yes. Table.
File Name	rptgen_sl.cs1_blk_count

See Also

Block Loop, Model Loop, System Loop

Purpose

Create list of signals exiting from Bus Selector block

Description

This component creates a list of signals exiting a Bus Selector block. The list contains signals leaving from the reported block or downstream buses and signals.

This component's parent determines which buses appear in the report:

- **Model Loop:** Includes all buses in the current model.
- **System Loop:** Includes all buses in the current system.
- **Block Loop :** Includes the current block if it is a bus block.
- **Signal Loop:** Includes all buses connected to the current signal.

If the Bus component does not have a looping component as its parent, it reports on all buses in all open models.

Properties

- **Show Bus Hierarchy:** Specifies whether the list displays downstream buses hierarchically.
- **Insert linking anchor for bus blocks:** Inserts a linking anchor for each bus block. This designates the list item as the location to which other links for that block point. (For more information, see the [Simulink Linking Anchor](#) or [Link](#) component reference pages.) Do not use this option if you have already specified an anchor location for the bus block with an [Object Linking Anchor](#) component.
- **Insert linking anchor for signals:** Inserts a linking anchor for each signal. This designates the list item as the location to which other links for that signal point. For more information, see the [Simulink Linking Anchor](#) or [Link](#) component reference pages.) Do not use this option if you have already specified an anchor location for the signal with an [Object Linking Anchor](#) component.
- **Title:** Inserts a title before each list. This attribute supports the `%<varname>` notation. For more information, see `%<VariableName>` [Notation on the Text component reference page](#) in the MATLAB Report Generator documentation.

**Insert
Anything
into
Report?**

Yes. List.

File Name

rptgen_sl.csl_blk_bus

See Also

Block Loop, Model Loop, Signal Loop, Simulink Linking Anchor,
System Loop,

Chart Loop

Purpose

Run child components for specified Stateflow charts

Description

This component runs its children for specified Stateflow charts.

Report On

- **Automatic list from context:** Report on all chart blocks in the context set by this component's parent component. Options for the parent component include:
 - **Model Loop:** Reports on all Stateflow chart blocks in the current model.
 - **System Loop:** Reports on all Stateflow chart blocks in the current system.
 - **Signal Loop:** Reports on all Stateflow chart blocks connected to the current signal.
 - **Machine Loop:** Reports on the current block if it is in a Stateflow chart.

If the Chart Loop component has any other type of component as its parent, selecting this option causes it to report on all Stateflow chart blocks.

- **Custom - use block list:** Reports on a specified list of Stateflow chart blocks.

Loop Options

Choose chart block sorting options and reporting options in this pane.

- **Sort blocks:** Specifies how to sort blocks. This option is available if you select **Automatic list from context** in the **Report On** section, or if you select **Custom - use block list** and the **Sort blocks** option. Options include:
 - **Alphabetically by block name.** Sorts blocks alphabetically by name.
 - **Alphabetically by system name.** Sorts systems alphabetically by name. Blocks in each system are listed, but in no particular order.

- Alphabetically by full Simulink path. Sorts models alphabetically by their full paths.
- By block type. Sorts blocks alphabetically by block type.
- By depth. Sorts blocks by their depth in the model.
- By simulation order. Sorts blocks by execution order.
- %<VariableName>: Inserts the value of a variable from the MATLAB workspace. The %<> notation can denote a string or cell array. For more information, see %<VariableName> Notation on the Text component reference page in the MATLAB Report Generator documentation.

If you do not select this option, chart blocks are reported on in the order in which they are listed in the chart list.

- **Search for Simulink property name/property value pairs:** Reports on Simulink blocks with specified property name/property value pairs.
- **Search Stateflow:** Reports on Stateflow charts with specified property name/property value pairs.

Section Options

- **Create section for each object in loop:** Inserts a section in the generated report for each object found in the loop.
- **Display the object type in the section title:** Inserts the object type automatically into the section title in the generated report.
- **Create link anchor for each object in loop:** Creates a hyperlink to the object in the generated report

Insert Anything into Report?

Yes, inserts a section if you select the **Create section for each object in loop** option.

File Name

rptgen_sf.csf_chart_loop

Chart Loop

See Also

Block Loop, Machine Loop, Model Loop, Signal Loop, System Loop

- Purpose** Insert version number information, list of generated files, tables summarizing code generation configuration information, and subsystem maps into report
- Description** This component reports the following information:
- Version number information
 - List of generated files
 - Code generation configuration information
 - Subsystem map
- Summary**
- **General information:** Includes the following information in the report:
 - Model name and version
 - Real-Time Workshop version number
 - List of full paths of generated files
 - **Configuration settings:** Includes tables that list optimization and Real-Time Workshop target selection and build process Configuration Parameter settings.
 - **Subsystem map:** Includes in the report a unique mapping between subsystem numbers and subsystem labels in the model.
- Traceability Report**
- Use settings from model:** When you select this option, the report uses all of the following configuration settings, as specified in your model. Deselecting this option allows you to turn off one or more of these settings as needed:
- **Eliminated/virtual blocks**
 - **Traceable blocks**
 - **Traceable StateFlow Objects**
 - **Traceable Embedded MATLAB Functions**

Code Generation Summary

For more information on these configuration settings, see “Real-Time Workshop Pane: Report” in the Real-Time Workshop documentation.

**Insert
Anything
into
Report?**

Yes. Tables and list.

File Name

RptgenRTW.CCodeGenSummary

See Also

Import Generated Code

Purpose

Insert text extracted from DocBlock blocks in Simulink models

Description

This component inserts text extracted from DocBlock blocks in Simulink models. It can have the following components as its parent:

- Model Loop
- System Loop
- Block Loop

The specified report format determines the format of the DocBlock block data inserted into the report:

- HTML: Imports HTML data into the report.
- RTF: Imports RTF data into the report.

Properties

- **Import file as:** Specifies how to format the imported information. The following example demonstrates how each option works, using the following text as input:

```
First row.  
Second row.
```

```
Third row follows blank line.
```

- Plain text (ignore line breaks). Imports plain text without any line breaks (no paragraphs), as in this example:

```
First row. Second row. Third row follows blank line.
```

- Paragraphs defined by line breaks. Imports the text contained in paragraphs defined by line breaks (hard returns or carriage returns), as in this example:

```
First row.  
Second row.
```

Third row follows blank line.

- Paragraphs defined by empty rows. Imports text contained in paragraphs defined by empty rows (rows that do not contain text), as in this example:

First row. Second row.

Third row follows blank line.

- Text (retain line breaks). Imports plain text, including line breaks, as in this example:

First row.
Second row.

Third row follows blank line.

- Fixed-width text (retain line breaks). Imports fixed-width text (all letters have the same width or size) including line breaks, as in this example:

First row.
Second row.

Third row follows blank line.

Tip This option is useful for importing M-files.

- **Insert linking anchor for blocks:** Inserts a linking anchor for each DocBlock block that designates the location where other links for that block point. (See the Simulink Linking Anchor or Link component reference pages for more help.) Do not use this option if you have already specified an anchor location for a DocBlock block with an Object Linking Anchor component.

**Insert
Anything
into
Report?**

Yes. Text, paragraph, or external RTF/HTML data.

File Name

rptgen_sl.csl_blk_doc

See Also

Block Loop, Model Loop, Simulink Linking Anchor, System Loop

Fixed Point Block Loop

Purpose Run child components for the Simulink model, system, or signal defined by parent component

Description This component runs its children for the Simulink model, system, or signal defined by its parent component. Options for the parent component are:

- Model Loop
- System Loop
- Signal Loop

Report On

- **Automatic list from context:** Reports on all fixed-point blocks in the context of this component's parent. For example, if the parent component is the `System Loop`, this component reports on all fixed-point blocks in the current system. If this component does not have a looping component as its parent, selecting this option causes the component to report on all fixed-point blocks in all models.
- **Custom - use block list::** Reports on a specified list of blocks.

Loop Options Choose block sorting options and reporting options in this pane.

- **Sort blocks:** Specifies how to sort blocks. This option is available if you select the `Automatic list from context` option in the **Report On** section, or if you select `Custom - use block list` and the `Sort blocks` options. Options include:
 - `Alphabetically by block name.` Sorts blocks alphabetically by name.
 - `Alphabetically by system name.` Sorts systems alphabetically. Blocks in each system are listed, but in no particular order.
 - `By fixed point block type.` Sorts blocks alphabetically by block type.
 - `By fixed point block depth.` Sorts blocks by their depth in the model.

- By traversal order. Sorts blocks by traversal order.
- By simulation order. Sorts blocks by execution order.
- %<VariableName>: Inserts the value of a variable from the MATLAB workspace. For more information, see %<VariableName> Notation on the Text component reference page in the MATLAB Report Generator documentation.
- **Search for Simulink property name/property value pairs:** Reports only on blocks with specified property name/property value pairs.

Section Options

- **Create section for each object in loop:** Inserts a section in the generated report for each object found in the loop.
- **Display the object type in the section title:** Inserts the object type automatically into the section title in the generated report.
- **Create link anchor for each object in loop:** Creates a hyperlink to the object in the generated report.

Insert Anything into Report?

Yes, inserts a section if you select the **Create section for each object in loop** option.

File Name

rptgen_fp.cfp_blk_loop

See Also

Block Loop, Model Loop, Signal Loop, Simulink Linking Anchor, System Loop

Fixed Point Logging Options

Purpose

Set fixed-point options like in Fixed Point Tool

Description

This component sets fixed-point options like those set in the Fixed Point Tool (invoked by running the `fxptdlg` function).

This component must be a child of the `Model Loop` component. Use this component to set the following options on the current model:

- Data type override
- Logging mode
- Logging type

This component can have child components. It is a good practice to use this component with a `Model Simulation` component as its child. This sets fixed-point properties for the model for the purpose of the simulation, and then restores them to their original values after the simulation is complete.

Data Type Override

- **Use local settings:** Data types are overridden according to the value of this parameter set for each subsystem. Otherwise, settings for parent systems override those of child systems.
- **Scaled doubles:** The output data type of all blocks in the current system or subsystem is overridden with doubles; however, the scaling and bias specified in the mask of each block is maintained.
- **True doubles:** The output data type of all blocks in the current system or subsystem is overridden with true doubles. The overridden values have no scaling or bias.
- **True singles:** The output data type of all blocks in the current system or subsystem is overridden with true singles. The overridden values have no scaling or bias.
- **Force off:** No data type override is performed on any block in the current system or subsystem.

Logging Mode

Specify logging options in this section. If a block is logged, minimum and maximum simulation values are written to the workspace. Options include:

- **Use local settings:** Data is logged according to the value of this parameter set for each subsystem. Otherwise, settings for parent systems always override those of child systems.
- **Min, max, and overflow:** Minimum value, maximum value, and overflow data is logged for all blocks in the current system or subsystem.
- **Overflow only:** Only overflow data is logged for all blocks in the current system or subsystem.
- **Force off:** No data is logged for any block in the current system or subsystem. Use this selection to work with models containing fixed point-enabled blocks, if you do not have a Simulink Fixed Point license.

For more information on logging simulation results, see “Tutorial: Feedback Controller” in the Simulink Fixed Point documentation.

Logging Type

Specify how to record logs in this section:

- **Overwrite log:** Information in the logs is cleared before new logging data is entered.
- **Merge log:** New logging data is merged with previously logged information.

Insert Anything into Report?

No.

File Name

rptgen_fp.cfp_options

Fixed Point Logging Options

See Also

Model Simulation

Purpose

Insert table that reports on Simulink Fixed Point block property name/property value pairs

Description

This component inserts a table that reports on Simulink Fixed Point block property name/property value pairs.

Table

Select a preset table, which is already formatted and configured, in the **preset table** list in the upper-left corner of the attributes page. Options include:

- **preset table**

Specifies the type of object property table. Options include:

- Default
- Mask properties
- Block limits
- Out-of-range errors
- All fixed-point properties
- Blank 4x4

To apply the specified table, select the table and click **Apply**.

- **Split property/value cells:** Split property name/property value pairs into separate cells. For the property name and property value to appear in adjacent horizontal cells in the table, select the **Split property/value cells** check box. In this case, the table is in split mode, so there only one property name/property value pair can exist in a cell. If there is more than one name/property pair in a cell, only the first pair appears in the report; all subsequent pairs are ignored.

For the property name and property value to appear together in one cell, clear the **Split property/value cells** check box. This is nonsplit mode. Nonsplit mode supports more than one property name/property value pair and text.

Before switching from nonsplit mode to split mode, make sure that there is only one property name/property value pair per table cell. If

Fixed Point Property Table

you have more than one property name/property value pair or text in one cell, only the first property name/property value pair appears in the report; subsequent pairs and text are omitted.

- **Display outer border:** Display the outer border of the table in the generated report.

Table Cells

Select table properties to modify. The selection in this pane affects the available fields in the **Cell Properties** pane.

Cell Properties

- **Contents**
Modify the contents of the table cell selected in the **Table Cells** pane.
- **Show as:** Specifies the format for the contents of the table cell. Options include:
 - PROPERTY Value
 - Value
 - Property Value
 - Property: Value
 - PROPERTY: Value
 - Property - Value
 - PROPERTY - Value
- **Alignment:** Aligns the contents of the table cell. Options are:
 - Center
 - Left
 - Right
 - Double justified
- **Lower border:** Displays the lower border of the table in the generated report.

- **Right border:** Displays the right border of the table in the generated report.

Creating Custom Tables

To create a custom table, edit a preset table, such as the Blank 4x4 table. Add and delete rows and add properties. To open the Edit Table dialog box, click **Edit**.

For details about creating custom property tables, see “Working with Property Table Components” on page 5-9.

Insert Anything into Report?

Yes. Table.

File Name

rptgen_fp.cfp_prop_table

See Also

Fixed Point Summary Table

Fixed Point Summary Table

Purpose Display table of specified fixed-point block properties or parameters

Description This component displays properties or parameters of specified fixed-point blocks in a table.

Properties **Table title**
Choose a table title in the generated report:

- **Automatic:** Generates a title automatically from the parameter.
- **Custom:** Specifies a custom title.

Property Columns **Property name**
This field displays the object properties to include in the Summary Table in the generated report.

- To add a property:
 - 1** Select the appropriate property level in the menu
 - 2** Select the property to add from the selection list and click **Add**.
- To delete a property, select the property name and click the **Delete** button.
- To move properties up and down in the list, click the **Up** and **Down** buttons.

Note Some entries in the list of available properties (such as `Depth`) are “virtual” properties that you cannot access using the `get_param` command. The properties used for property/value filtering in the block and system loop components must be retrievable by the `get_param`. Therefore, you cannot configure your Summary Table to report on all blocks of `Depth == 2`.

Fixed Point Summary Table

Object Rows

- **Insert anchor for each row:** Inserts an anchor for each row in the summary table.
- **Report On:** Specifies blocks on which to report:
 - **Automatic list from context.** Reports on all blocks in the current context.
 - **Custom - use block list.** Reports on a specified list of blocks. To include a given block in the report, specify its full path.

Loop Options

- **Sort blocks:** Specifies how to sort blocks:
 - **Alphabetically by block name.** Sorts blocks alphabetically by name.
 - **Alphabetically by system name.** Sorts systems alphabetically. Blocks in each system are listed, but in no particular order.
 - **Alphabetically by full Simulink path.** Sorts blocks alphabetically by Simulink path.
 - **By block type.** Sorts blocks alphabetically by block type.
 - **By block depth.** Sorts blocks by their depth in the model.
 - **By traversal order.** Sorts blocks by traversal order.
 - **By simulation order.** Sorts blocks by execution order.
- **Search for Simulink property name/property value pairs:** Reports only on Simulink blocks with specified property name/property value pairs.

Insert Anything into Report?

Yes. Table.

File Name

rptgen_fp.cfp_summ_table

Fixed Point Summary Table

See Also

Fixed Point Property Table

Purpose	Import source and header files generated by Real-Time Workshop software, and custom files specified as part of model
Description	This component imports source and header files generated by Real-Time Workshop software. It also imports custom files that you specify as part of your model.
Properties	<ul style="list-style-type: none">• Source files (auto-generated): Includes the following files in the report:<ul style="list-style-type: none">▪ .c and .cpp source files generated by Real-Time Workshop software.▪ Real-Time Workshop source files, such as the template main file and supporting files in the build directory. This check box is selected by default. Clear it to omit source files.• Header files (auto-generated): Includes the following files in the report:<ul style="list-style-type: none">▪ .h and .hpp header files generated by Real-Time Workshop software.▪ Real-Time Workshop header files in the build directory. This check box is selected by default. Clear it to omit source files.• Custom files: Includes custom source files that you specify in the Real-Time Workshop > Custom Code pane of the Configuration Parameters dialog box. This check box is deselected by default.
Insert Anything into Report?	Yes. Generated code listings.
File Name	RptgenRTW.CImportCode
See Also	Code Generation Summary

Look-Up Table

Purpose Report on lookup table blocks

Description The Look-Up Table component reports on the following Lookup table blocks:

- Lookup Table
- Lookup Table (2-D)
- Lookup Table (n-D)

It inserts a figure and/or table into the report. The table contains input and output numeric values; a figure plots these values.

Look-Up Table Options

This pane allows you to specify the types of lookup table blocks to include in the report and how they appear. If none of the check boxes in this pane are selected, the component does not insert anything into the report.

- The Look-Up Table displays results according to the type of its parent component:
 - **Model Loop:** Includes all lookup tables in the current model.
 - **System Loop.:** Includes all lookup tables in the current system.
 - **Block Loop.:** Includes the current block if it is a lookup table.
 - **Signal Loop:** Includes all lookup tables connected to the current signal.
 - If the Look-Up Table does not have any of the looping components as its parent, it includes all lookup tables in all open models.
- **Plot 1-D data:** Plots data from a lookup table block. Choose the plot type, **Line plot** or **Bar plot**, from the corresponding list. The input data appears on the horizontal or *x*-axis, and the output data appears on the vertical or *y*-axis.

For more information on line and bar plots, see “Types of MATLAB Plots” in the MATLAB Graphics documentation.

- **Create table for 1-D data:** Creates a table that contains numeric data values from the `lookup table` block.
- **Plot 2-D data:** Creates a plot of 2-D `lookup table` blocks. You can specify whether the data appears as a surface plot or a line plot. The line plot is best for small data sets, and the surface plot for larger tables. For more information on surface and line plots, see “Types of MATLAB Plots” in the MATLAB Graphics documentation.

Note This is a 2-D slice through n-D data.

- **Create table for 2-D data:** Creates a table that contains numeric data values from the `lookup table (2-D)` block.
- **Create table for N-D data:** Creates a table that contains numeric data values from the `lookup table (n-D)` block.
- **Image file format:** Specifies the image file format. Select `Automatic HG Format` (the default) to automatically choose the format best suited for the output format that you chose in the Report component. Otherwise, choose an image format that your output viewer can read. Options include:
 - `Automatic SL Format` (Uses the Simulink file format selected in the Preferences dialog box)
 - `Adobe Illustrator`
 - `Bitmap (16m-color)`
 - `Bitmap (256-color)`
 - `Black and white encapsulated PostScript`
 - `Black and white encapsulated PostScript (TIFF)`
 - `Black and white encapsulated PostScript2`
 - `Black and white encapsulated PostScript2 (TIFF)`

Print Options

Look-Up Table

- Black and white PostScript
- Black and white PostScript2
- Color encapsulated PostScript
- Color encapsulated PostScript (TIFF)
- Color encapsulated PostScript2
- Color encapsulated PostScript2 (TIFF)
- Color PostScript
- Color PostScript2
- JPEG high quality image
- JPEG medium quality image
- JPEG low quality image
- PNG 24-bit image
- TIFF - compressed
- TIFF - uncompressed
- Windows metafile
- **Paper orientation:** Options include:
 - Landscape
 - Portrait
 - Rotated
 - Use figure orientationFor more information on paper orientation, see `orient` in the MATLAB documentation.
- **Image size:** Allows you to specify the image size in the report by selecting `Use figure PaperPositionMode` setting and setting the `PaperPositionMode` property of the Handle Graphics figure. Options include:

- Automatic (same size as on screen):
- Custom: Specifies a custom image size. Set the image size using the **Size** field and **Units** list.

For more information on paper position mode, see `orient` in the MATLAB documentation.

- **Size:** Allows you to enter the size of the Handle Graphics figure snapshot in the format `wxh`(width times height). This field is active only if you choose **Custom** in the **Image size** list box.
- **Units:** Allows you to enter for the size of the Handle Graphics figure snapshot. This field is active only if you choose **Custom** in the **Image size** list box.
- **Invert hardcopy:** Causes the Handle Graphics `InvertHardcopy` property to invert colors for printing; that is, it changes dark colors to light colors and vice versa. To change colors in your image, choose one of the following options:
 - **Automatic:** Automatically changes dark axes colors to a light axes color. If the axes color is a light color, it is not inverted.
 - **Invert:** Changes dark axes colors to light axes colors and vice versa.
 - **Don't invert:** Does not change the colors in the image that appears on the screen for printing.
 - **Use figure's InvertHardcopy setting:** Uses the `InvertHardcopy` property set in the Handle Graphics image.
 - **Make figure background transparent:** Makes the image background transparent.
- **Scaling:** Options include:
 - **Fixed size:** Specifies the number and type of units.
 - **Zoom:** Specifies the percentage, maximum size, and units of measure.

Display Options

Look-Up Table

- **Use image size:** Sets the size of the image in the report to the same size as it is on screen.
- **Size:** Specifies the size of the snapshot in the form w h (width height) format. This field is active only if you choose **Fixed size** in the **Scaling** selection list.
- **Max size:** Specifies the maximum size of the snapshot in the form w h (width height). This field is active only if you choose **Zoom** from the **Scaling** selection list.
- **Units:** Allows you to enter units for the size of the snapshot. This field is active only if you choose **Zoom** or **Fixed size** in the **Image size** list box.
- **Alignment:** Only PDF and RTF reports support this option. Options include:
 - Auto
 - Right
 - Left
 - Center
- **Title:** Enter text to appear above the snapshot.
- **Caption:** Enter text to appear under the snapshot.

Insert Anything into Report?

Yes. Figure and/or table.

File Name

rptgen_sl.csl_blk_lookup

See Also

Block Loop, Model Loop, Signal Loop, System Loop

Purpose	Run child components for specified Stateflow machines
Description	This component runs its child components for selected Stateflow machines. The behavior of this component depends on its parent component. If it has no parent, the Machine Loop runs its child components for all machines. If it has the Model Loop as its parent, it runs its child components for all machines in the model.
Loop Options	Search Stateflow If selected, searches states that you specify in the field that appears under the check box.
Section Options	<ul style="list-style-type: none">• Create section for each object in loop: Inserts a section in the generated report for each object in the loop.• Display the object type in the section title: Inserts the object type automatically into the section title in the generated report.• Create link anchor for each object in loop: Creates a hyperlink to each object in the loop.
Insert Anything into Report?	Yes, inserts a section if you select the Create section for each object in loop option.
File Name	rptgen_sf.csf_machine_loop
See Also	Model Loop

Model Advisor Report

Purpose	Insert Model Advisor report or link to Model Advisor report for current model
Description	This component inserts a Model Advisor report for the current model into the report if the report is in HTML format. For other report formats, it inserts a link to a Model Advisor report for the current model. For more information about Model Advisor reports, see “About the Model Advisor” in the Simulink documentation.
Properties	Use existing report: Includes an existing Model Advisor report in the report. This check box is selected by default. If you clear it, a new Model Advisor report is generated.
Insert Anything into Report?	Yes, a Model Advisor report.
File Name	rptgen_sl.CModelAdvisor
See Also	Model Change Log

Purpose Construct model history table that displays model revision information

Description This component should run before the Model Simulation component. It uses a reported model's ModifiedHistory parameter to construct a model history table that displays information about each logged revision to the model. This model history table includes:

- The author of each change
- The model version of the change
- The time and date of the change
- A description of the change

For more information on model history, see “Creating a Model Change History” in the Simulink documentation.

Tip If your model has a long revision history, you may want to limit the number of revisions reported.

Table Columns Choose the information displayed in the model revision table in this section:

- **Author name:** Includes the name of the person who last revised the model.
- **Version:** Includes the model's version number.
- **Date changed:** Includes the date on which the model was revised.
- **Description of change:** Includes a description of the revision to the model.

Model Change Log

Table Rows

- **Limit displayed revisions to:** Limits the number of revisions that appears in the report.
- **Show revisions since date:** Limits the number of revisions that appears in the report by date. Enter the date in the corresponding text field. This field supports %<varname> notation. For example, the default value, %<datestr(now-14)>, returns revision history for the last two weeks.

Table Display

Choose how the model revision history table appears in this section.

- **Table title:** Specifies the title of the table.
- **Sort order:** Sorts the table entries from most recent to oldest, or vice-versa.
- **Date format:** Specifies a preferred date format for the date/time stamps in the table.

Insert Anything into Report?

Yes. Table.

File Name

rptgen_sl.csl_md1_changelog

See Also





Model Advisor Report

Purpose Loop on Simulink models and systems, as specified by child components

Description This component loops on Simulink models and systems, as specified by child components. For example, you can use a Model Loop with a child System Loop to report on the specified system's subsystems.

It is a good practice to make these components children of the Model Loop (although the Model Loop is not necessarily required to be a given component's immediate parent).

Models to Include You can add a model to the list by clicking **Add New Model to List**. The following table shows the buttons you can use to move a model up or down in the list, or to add or delete a model.

Button	Action
	Move a model up in the list.
	Move a model down in the list.
	Remove a model from the list.
	Add a new model to the list.

Model Options

- **Active:** Includes a given model in the loop. This option is selected by default. Deselecting this option omits the model from the loop.

This option allows you to temporarily omit one or more models from a report.

- **Model name:** Specifies the model name. Options include:
 - Current block diagram
 - All open models
 - All open libraries

Model Loop

- Block diagrams in current directory
- Custom block diagram: Selecting this option automatically sets the **Starting system(s)** field to \$top, which denotes the model root.
- %<VariableName>: For more information, see %<VariableName> Notation on the Text component reference page in the MATLAB Report Generator documentation.
- **Traverse model:** Specifies the system(s) to traverse. Options include:
 - All systems in model
 - Selected system(s) only
 - Selected system(s) and ancestors
 - Selected system(s) and children
- **Look under masks:** Specifies how to handle masks. Options include:
 - Functional masks only
 - No masks
 - All masks
 - Graphical masks onlyFor more information, see “About Masks” in the Simulink documentation.
- **Follow library links:** Specifies library links to include. Options include:
 - Do not follow library links
 - Include library links
 - Include unique library linksFor more information, see “Creating a Reference Block” in the Simulink documentation.

- **Starting system(s):** Specifies the system in which to start the loop. Available options in this list depend on the value you select in the **Traverse model** list. Selecting any option other than **All systems** in **model** for **Traverse model** activates the **Starting system(s)** field. This enables you to enter the full path of a subsystem or subsystems.

Other options include:

- `$top`: Starts in the model root system.
- `$current`: Starts in the currently selected system.

Section Options

- **Create section for each object in loop:** Inserts a section in the generated report for each object found in the loop.
- **Display the object type in the section title:** Inserts the object type automatically into the section title in the generated report.
- **Create link anchor for each object in loop:** Creates a hyperlink to the object in the generated report.

Examples

Generating Reports on Specified Systems and their Subsystems

This example shows how to loop over a specified system and its subsystems in the sample model `sldemo_auto_climate_elec`, which is provided with the Simulink software.

- 1 (Optional) Enter the following command at the MATLAB command prompt to open the `sldemo_auto_climate_elec` model:

```
sldemo_auto_climate_elec
```

Explore the model and familiarize yourself with its subsystems.

- 2 Open the Report Explorer.
- 3 Create a new report template by clicking **File > New**.
- 4 Save the report template by clicking **File > Save As**. Give it the name `sldemo_auto_report`.

Model Loop

- 5 Add a Chapter/Subsection component to the report template, to include information about the model's subsystems:
 - a In the Options pane in the middle, double-click Chapter/Subsection to add it to the report template.
 - b For **Title**, choose Custom. In the title field, enter Description of sldemo_auto_climate_elec subsystems.
- 6 Add a Model Loop as a child of the Chapter/Subsection component. This loops over the ClimateControlSystem system and its subsystems in the sldemo_auto_climate_elec model:
 - a In the Options pane in the middle, double-click Model Loop to add it to the report template. By default, it is added as a child of the Chapter/Subsection component.
 - b In the Model Loop properties pane, select <Custom block diagram> from the **Model name** selection list.
 - c Delete the text <Custom block diagram> from the **Model name** field, and then enter sldemo_auto_climate_elec.mdl. Click any component in the report template to add this model to the **Models to include** list.
 - d In the **Traverse model** selection list, select Selected system(s) and children.
 - e In the **Look under masks** selection list, select All masks.
 - f In the **Starting system(s)** field, enter sldemo_auto_climate_elec/ClimateControlSystem. Because you selected Selected system(s) and children for **Traverse model**, the Model Loop loops over sldemo_auto_climate_elec/ClimateControlSystem and its subsystems.
 - g Under **Section Options**, select the **Create section for each object in loop** check box. Selecting this option creates separate sections in the generated report for each model over which this component loops.

The Model Loop properties pane looks as follows.

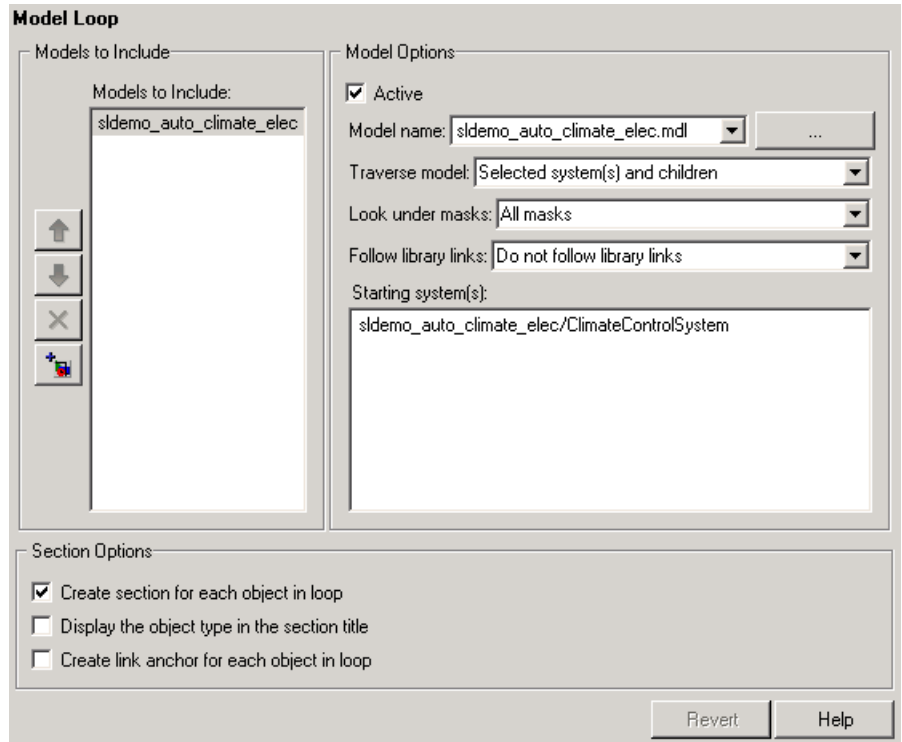

7 Save the report by clicking **File > Save**.

Model Loop

- 8 Add a System Loop as a child of the Model Loop component.
 - a In the Options pane in the middle, double-click System Loop to add it to the report template. By default, it is added as a child of the Model Loop.
 - b In the System Loop properties pane, under **Section Options**, select the **Create section for each object in loop** check box. Selecting this option creates a section in the generated report for each subsystem on which this component loops. Accept the default values for all other fields.
- 9 Add a System Snapshot component as a child of the System Loop component. This creates snapshots of all the subsystems of ClimateControlSystem in the generated report. Double-click System Snapshot In the Options pane in the middle. By default, it is added as a child of the System Loop component.
- 10 Save the report.

The report template hierarchy now looks as follows.

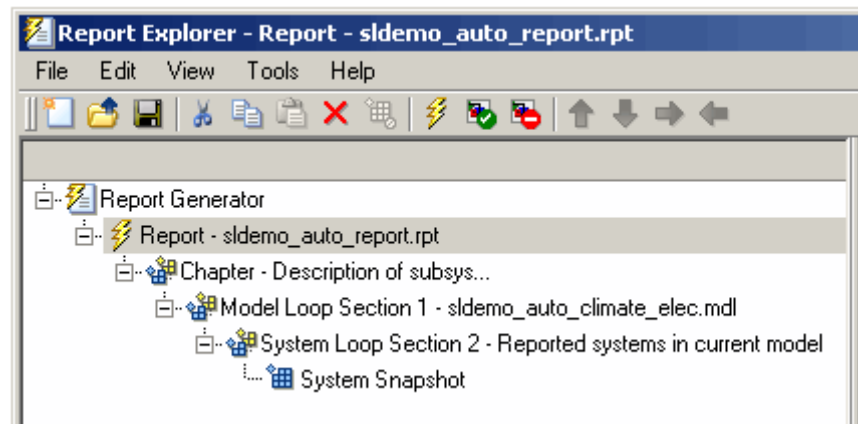

- 11 Run the report by clicking **File > Report**.

The report loops on the system ClimateControlSystem of the sldemo_auto_climate_elec model and all of its subsystems, as shown in the following Message List.

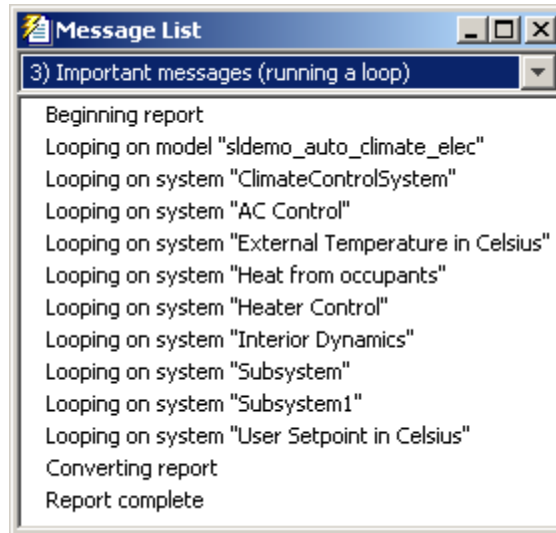

The report looks as follows.

Model Loop

file:///C:/WINNT/Profiles/nlum/Desktop/sldemo_auto_report.html

File Edit View Go Debug Project Desktop Window Help

Location: file:///C:/TEMP/sldemo_auto_report.html

Table of Contents

- [1. Description of subsystem](#)
 - [sldemo_auto_climate_elec](#)
 - [ClimateControlSystem](#)
 - [AC Control](#)
 - [External Temperature in Celsius](#)
 - [Heat from occupants](#)
 - [Heater Control](#)
 - [Interior Dynamics](#)
 - [Subsystem](#)
 - [Subsystem1](#)
 - [User Setpoint in Celsius](#)

Chapter 1. Description of subsystem

Table of Contents

- [sldemo_auto_climate_elec](#)
 - [ClimateControlSystem](#)
 - [AC Control](#)
 - [External Temperature in Celsius](#)
 - [Heat from occupants](#)
 - [Heater Control](#)
 - [Interior Dynamics](#)
 - [Subsystem](#)
 - [Subsystem1](#)
 - [User Setpoint in Celsius](#)

sldemo_auto_climate_elec

ClimateControlSystem

Done

Temporarily Omitting a Model from a Loop

This example shows how to use the Model Loop **Active** check box to temporarily omit a model from the loop. This example uses the report template that you created in *Generating Reports on Specified Systems and their Subsystems*, `sldemo_auto_report.rpt`, and the model `f14.mdl`, which is provided with the Simulink software.

- 1 Click **File > Open** in the Report Explorer, and then open `sldemo_auto_report.rpt` by double-clicking it.
- 2 In the Outline pane on the left, click Model Loop Section 1 - `sldemo_auto_climate_elec`.
- 3 In the Model Loop properties pane, click the  button to add a model to the **Models to include** list.
- 4 In the Model Loop properties pane, select <Custom block diagram> from the **Model name** selection list.
- 5 Delete the text <Custom block diagram> from the **Model name** field, and enter `f14.mdl`.

The Model Loop properties pane now looks as follows.

Model Loop

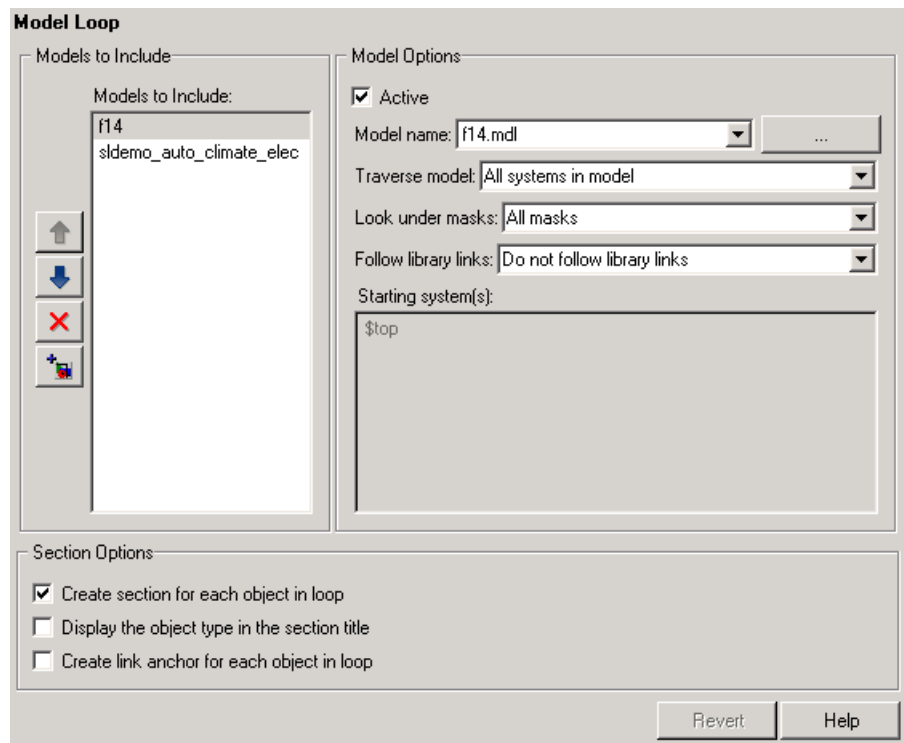

6 Save the report template.

7 Generate the report.

The report generation process loops over the specified systems in the f14 and sldemo_auto_climate_elec models, as shown in the following message box.

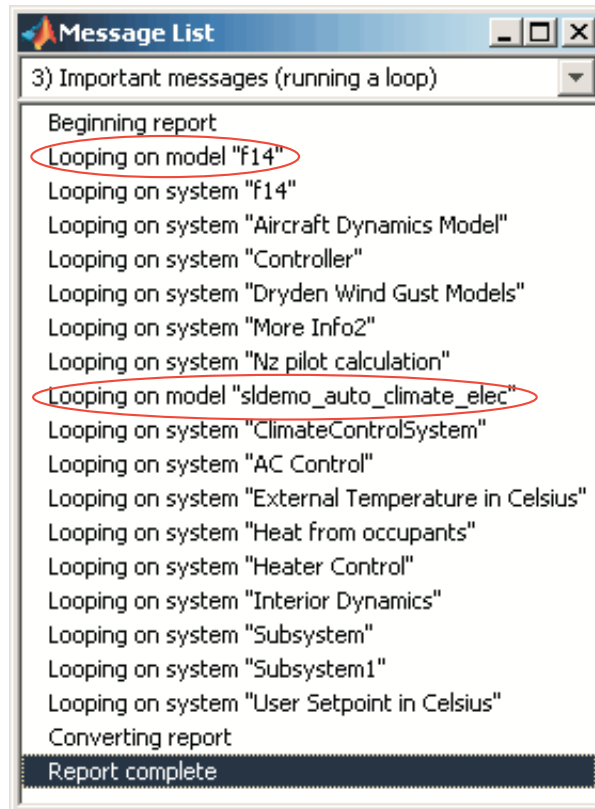

The report looks as follows.

Model Loop

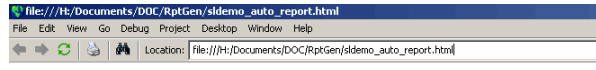

Table of Contents

[1. Description of subsystem](#)

- [f14](#)
- [f14](#)
- [Aircraft Dynamics Model](#)
- [Controller](#)
- [Dryden Wind Gust Models](#)
- [More Info?](#)
- [Nz pilot calculation](#)
- [sldemo_auto_climate_elec](#)
- [ClimateControlSystem](#)
- [AC Control](#)
- [External Temperature in Celsius](#)
- [Heat from occupants](#)
- [Heater Control](#)
- [Interior Dynamics](#)
- [Subsystem](#)
- [Subsystem1](#)
- [User Setpoint in Celsius](#)

Chapter 1. Description of subsystem

Table of Contents

- [f14](#)
- [f14](#)
- [Aircraft Dynamics Model](#)
- [Controller](#)
- [Dryden Wind Gust Models](#)
- [More Info?](#)
- [Nz pilot calculation](#)
- [sldemo_auto_climate_elec](#)
- [ClimateControlSystem](#)
- [AC Control](#)
- [External Temperature in Celsius](#)
- [Heat from occupants](#)
- [Heater Control](#)
- [Interior Dynamics](#)
- [Subsystem](#)
- [Subsystem1](#)
- [User Setpoint in Celsius](#)

f14

f14

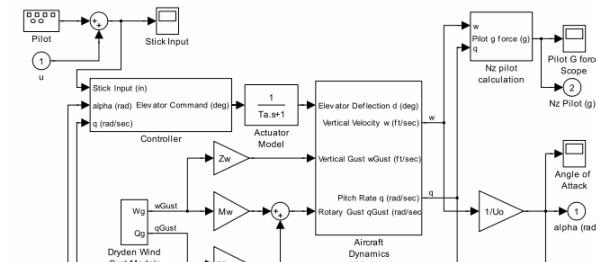

8 In the **Models to include** list, click f14 to select it.

9 Clear the **Active** check box to omit f14 model information from the generated report.

10 Rerun the report.

The report now includes information only on the `sldemo_auto_climate_elec` model, as shown at the end of the previous example, *Generating Reports on Specified Systems and their Subsystems*.

11 To reactivate the f14 model, select it in the Model Loop **Models to include** list and select the **Active** check box.

Insert Anything into Report?

Yes, inserts a section if you select the **Create section for each object in loop** option.

File Name

`rptgen_sl.csl_md1_loop`

See Also

Block Loop, System Loop

Model Simulation

Purpose

Run current model with specified simulation parameters

Description

This component runs the current model using specified simulation parameters. This component should have the `Model Loop` component as its parent.

For more information on simulation parameters, see:

- “Configuration Parameters Dialog Box” in the Simulink documentation.
- The `simset` function in the Simulink documentation.

I/O Parameters

Use model’s workspace I/O variable names

Use the names of the parameters specified in the Simulation Parameters dialog box.

The following options are available if you do not select the **Use model’s workspace I/O variable names** option:

- **Time** : Specifies a new variable name for the `Time` parameter.
- **States**: Specifies a new variable name for the `States` parameter.
- **Output**: Specifies a new variable name for the `Output` parameter.

Timespan

Use model’s timespan values: Use the model’s `Start time` and `Stop time` values, as specified in the **Solver** tab in the Simulation Parameters dialog box.

The following options are available if you do not select the **Use model’s timespan values** option:

- **Start**: Specifies a simulation starting time.
- **Stop**: Specifies a simulation ending time.

Note If you set your model's stop time to `inf` (infinity) in Simulink or on this component's attribute page, Simulink Report Generator terminates the model simulation after 60 seconds to prevent the report generation process from entering an infinite loop.

Simulation Options

- **Compile model before simulation:** Compiles the model before simulating, preserving scope content. Select this option if:
 - You use Real-Time Workshop Summary properties.
 - You sort systems or blocks by simulation order.
 - You use scope snapshots.
- **Simulation status messages:** Displays simulation status messages, or inserts them into the report. Options include:
 - **Display to command line:** Sends messages to a command-line window.
 - **Display to Report Generator Message List:** Sends messages to the Simulink Report Generator message window.
 - **Insert into report:** Includes messages in the report.
- **Simulation parameters:** Specifies simulation parameters.

Insert Anything into Report?

No.

File Name

`rptgen_sl.csl_md1_sim`

See Also

Model Loop

Object Loop

Purpose	Run child components for Stateflow objects, and then insert table into report
Description	This component runs its child components for each Stateflow object and inserts a table into the generated report.
Object Types	<ul style="list-style-type: none">• Report on “Data” objects: Includes Stateflow data objects in the loop.• Report on “Event” objects: Includes Stateflow event objects in the loop.• Report on “Transition” objects: Includes Stateflow transition objects in the loop.• Report on “Junction” objects: Includes Stateflow junction objects in the loop.• Report on “Target” objects: Includes Stateflow target objects in the loop.• Report on “Note” objects: Includes Stateflow note objects in the loop.
Loop Options	<ul style="list-style-type: none">• Report depth: Specifies the level at which to loop:<ul style="list-style-type: none">▪ Local children only (Default). Reports only on children one level down.▪ All objects. Reports on all Stateflow objects.• Skip autogenerated charts under truth tables: Excludes autogenerated charts under truth tables from the report.• Remove objects which do not contain more information than a snapshot: Excludes objects that contain only a snapshot.• Search Stateflow: Reports on Stateflow charts with specified property name/property value pairs.

Section Options

- **Create section for each object in loop:** Inserts a section in the generated report for each object found in the loop.
- **Display the object type in the section title:** Automatically inserts the object type into the section title in the generated report.
- **Create link anchor for each object in loop:** Creates a hyperlink to the Stateflow object in the generated report.

Insert Anything into Report?

Yes, inserts a section if you select the **Create section for each object in loop** option.

File Name

rptgen_sf.csf_obj_loop

See Also

Stateflow Filter, Stateflow Hierarchy, Stateflow Hierarchy Loop

Requirement Block Loop

- Purpose** Apply child components to blocks with requirements
- Description** This component applies its child components to blocks with associated requirements.
- Report On**
- **Automatic list from context:** If selected, this option reports on all blocks in the current context. The Requirement Block Loop component's parent component determines its context. Options include:
 - **Model Loop:** Reports on all blocks in the current model.
 - **System Loop:** Reports on all blocks in the current system.
 - **Signal Loop:** Reports on all blocks connected to the current signal. If the Requirement Block Loop does not have the Model Loop, System Loop, Signal Loop, or Block Loop component as its parent, it reports on all blocks in all models.
 - **Custom - use block list:** Reports on a list of blocks with specified requirements. You must enter the full paths of each blocks into this field.
- Loop Options**
- **Sort blocks**
Specify how to sort blocks:
 - **Alphabetically by block name:** Sorts blocks alphabetically by name.
 - **Alphabetically by system name:** Sorts systems alphabetically by name. Blocks in each system are listed, but in no particular order.
 - **Alphabetically by full Simulink path:** Sorts blocks alphabetically by Simulink path.
 - **By block type:** Sorts blocks alphabetically by block type.
 - **By block depth:** Sorts blocks by their depth in the model.
 - **By traversal order:** Sorts blocks by traversal order.

- **By simulation order:** Sorts blocks by execution order.
- **Search for Simulink property name/property value pairs:** Reports on Simulink blocks with specified property name/property value pairs.

Section Options

- **Create section for each object in loop:** Inserts a section in the generated report for each block found in the loop.
- **Display the object type in the section title:** Inserts the object type automatically into the section title in the generated report.
- **Create link anchor for each object in loop:** Creates a hyperlink to the block in the generated report.

Insert Anything into Report?

Yes, inserts a section if you select the **Create section for each object in loop** option.

File Name

RptgenRMI.CReq_Block_Loop

See Also

Model Loop, Signal Loop, System Loop

Requirement System Loop

- Purpose** Apply child components to systems with requirements
- Description** This component applies its child components to systems with associated requirements.
- Report On**
- **Loop on systems**
 - **Select systems automatically:** If selected, this option reports on all systems in the current context. The component's parent determines its context:
 - **Model Loop:** Reports on systems in the current model.
 - **System Loop:** Reports on the current system.
 - **Signal Loop:** Reports on the current signal's parent system.
 - **Block Loop:** Reports on the current block's parent system.
 - **Custom - use system list:** Reports on a list of specified systems. Enter the full path of each system.
- If the Requirement System Loop does not have any of these components as its parent, selecting this option reports on all systems with requirements in all models.
- Loop Options**
- **Sort Systems:** Options include:
 - **Alphabetically by system name (default):** Sorts systems alphabetically by name.
 - **By number of blocks in system:** Sorts systems by the number of blocks in the system. The list displays systems by decreasing number of blocks; the system with the largest number of blocks appears first in the list.
 - **By system depth:** Sorts systems by their depth in the model.
 - **By traversal order:** Sorts systems in the order they are traversed.
 - **Search for:** Reports on Simulink blocks with specified property name/property value pairs.

Section Options

- **Create section for each object in loop:** Inserts a section in the generated report for each object found in the loop.
- **Display the object type in the section title:** Inserts the object type automatically into the section title in the generated report.
- **Number sections by system hierarchy:** Numbers sections in the generated report hierarchically.
- **Create link anchor for each object in loop:** Creates a hyperlink to the object in the generated report.

Insert Anything into Report?

Yes, inserts a section if you select the **Create section for each object in loop** option.

File Name

RptgenRMI.CReq_Sys_Loop

See Also

Block Loop, Model Loop, Signal Loop, System Loop

Requirements Summary Table

Purpose	Display properties of blocks, systems, or Stateflow objects with associated requirements
Description	This component displays properties of blocks, systems, or Stateflow objects with associated requirements.
Object Type	<p>Choose the object type to display in the generated report. Options include:</p> <ul style="list-style-type: none">• Block (Default)• System• Stateflow <p>The selected object type affects the options available in the Property Columns pane.</p>
Table Title	<p>Specify a table title in the generated report. Options include:</p> <ul style="list-style-type: none">• Automatic: Generates a title automatically from the parameter.• Custom: Specifies a custom title.
Property Columns	<ul style="list-style-type: none">• Object properties to include in the Requirements Summary Table appear in a list.<ul style="list-style-type: none">▪ To add a property:<ol style="list-style-type: none">1 Select the appropriate property level in the text box on the left.2 In the text box on the right, select the property that you want to add and click Add.▪ To delete a property, select the property name and click Delete. <p><code>%<SplitDialogParameters></code> is a unique property that can be specified for Requirements Summary Tables where the object type is Block. This property generates multiple summary tables, grouped</p>

Requirements Summary Table

by block type. Each Summary Table group contains the dialog box parameters for that block.

Some entries in the list of available properties (such as `Depth`) are “virtual” properties that you cannot access using the `get_param` command. The properties used for property/value filtering in the block and System Loop components must be retrievable by the `get_param`. Therefore, you cannot configure your Requirements Summary Table to report on all blocks of `Depth == 2`.

- **Remove empty columns:** Removes empty columns from the table.
- **Insert anchor for each row:** Inserts an anchor for each row in the Requirements Summary Table.
- **Report On**
 - **Automatic list from context:** Reports on all blocks in the current context. The parent of this component determines its context.
 - **Custom - use block list:** Reports on a list of blocks that you specify, and enter the block names in the corresponding field. Specify the full path of each block.

Object Rows

Loop Options

Choose block sorting options and reporting options in this pane.

- **Sort blocks**
 - **Alphabetically by block name:** Sorts blocks alphabetically by name.
 - **Alphabetically by system name:** Sorts systems alphabetically by name. Blocks in each system are listed, but in no particular order.
 - **Alphabetically by full Simulink path:** Sorts blocks alphabetically by Simulink path.
 - **By block type:** Sorts blocks alphabetically by block type.
 - **By block depth:** Sorts blocks by their depth in the model.

Requirements Summary Table

- By traversal order: Sorts blocks by traversal order.
- By simulation order: Sorts blocks by execution order.
- **Search for Simulink property name/property value pairs:**
Reports on blocks with specified property name/property value pairs.

**Insert
Anything
into
Report?**

Yes. Table.

File Name

RptgenRMI.CReq_Summ_Table

See Also

Block Loop

Purpose	Create table with requirements information from Simulink Verification and Validation software
Description	This component creates a table that contains information from the Simulink Verification and Validation software. Objects can have multiple requirements. Each requirement is a row in the table.
Table Options	<ul style="list-style-type: none">• Show requirements for current: Specifies the object type to display. Options include:<ul style="list-style-type: none">▪ Simulink object▪ Stateflow object• Table title: Specifies a title for the table. Options include:<ul style="list-style-type: none">▪ No title▪ Object name (Default)▪ Custom
Table Columns	<ul style="list-style-type: none">• Description: Includes the object description in the table.• Document name: Includes the report name in the table.• Locations within document: Includes the object's locations within the document in the table.• Requirement keyword: Includes the object's requirement keyword in the table.
Insert Anything into Report?	Yes. Table.
File Name	RptgenRMI.CReqTable
See Also	Stateflow Automatic Table, Stateflow Name

Scope Snapshot

Purpose

Insert images of Simulink scopes and XY graphs

Description

This component inserts images of Simulink scopes and XY graphs. If the model has not been simulated, scopes are empty. For more information, see the [Model Simulation](#) reference page.

The Scope Snapshot's parent component determines its behavior. Options include:

- **Model Loop or no Simulink looping component:** Includes all XY graphs and scopes in the current model.
- **System Loop:** Includes all XY graphs and scopes in the current system.
- **Block Loop:** Includes the current block if it is an XY graph or scope.
- **Signal Loop:** Includes all XY graphs and scopes connected to the current signal.

If the Scope Snapshot does not have any of the Simulink looping components as its parent, it includes all XY graphs and scopes in all open models.

Scope Options

- **Report on closed scopes:** Takes a snapshot of all scopes in context. This option forces closed scopes to open when the report is generating.
- **Autoscale time axis:** Scales the Simulink scope time axis to include the entire log.

Print Options

- **Image file format:** Specifies the image file format (e.g., JPEG, TIFF, etc.). Select **Automatic HG Format** (the default) to automatically choose the format best suited for the specified output format. Otherwise, choose an image format that your output viewer can read. Options include:
 - **Automatic HG Format** (uses the Simulink file format selected in the Preferences dialog box)
 - **Adobe Illustrator**

- Bitmap (16m-color)
- Bitmap (256-color)
- Black and white encapsulated PostScript
- Black and white encapsulated PostScript (TIFF)
- Black and white encapsulated PostScript2
- Black and white encapsulated PostScript2 (TIFF)
- Black and white PostScript
- Black and white PostScript2
- Color encapsulated PostScript
- Color encapsulated PostScript (TIFF)
- Color encapsulated PostScript2
- Color encapsulated PostScript2 (TIFF)
- Color PostScript
- Color PostScript2
- JPEG high quality image
- JPEG medium quality image
- JPEG low quality image
- PNG 24-bit image
- TIFF - compressed
- TIFF - uncompressed
- Windows metafile
- **Paper orientation:**
 - Landscape
 - Portrait
 - Rotated

Scope Snapshot

- Use figure orientation

For more information about paper orientation, see the `orient` reference page in the MATLAB documentation.

- **Image size:** Specifies the size of the Handle Graphics figure snapshot in the form [w h] (width height). In the units text box, select one of the follow options:
 - Inches
 - Centimeters
 - Points
 - Normalized
- **Invert hardcopy:** Inverts colors for printing; that is, changes dark colors to light colors and vice versa. Options include:
 - **Automatic:** Automatically changes dark axes colors to a light axes color. If the axes color is a light color, it is not inverted.
 - **Invert:** Changes dark axes colors to light axes colors and vice versa.
 - **Don't invert:** Does not change the colors in the image that appears on the screen for printing.
 - **Use figure's InvertHardcopy setting:** Uses the `InvertHardcopy` property set in the Handle Graphics image.
 - **Make figure background transparent:** Makes the image background transparent.
- **Scaling:**
 - **Fixed size:** Specifies the number and type of units.
 - **Zoom:** Specifies the percentage, maximum size, and units of measure.
 - **Use image size:** Causes the image to appear the same size in the report as on screen.

Display Options

- **Size:** Specifies the size of the snapshot in the form `w h` (width height). This field is active only if you choose `Fixed` size from the **Scaling** selection list.
- **Max size:** Specifies the maximum size of the snapshot in the form `w h` (width height). This field is active only if you choose `Zoom` from the **Scaling** selection list.
- **Units:** Specifies the units for the size of the snapshot. This field is active only if you choose `Zoom` or `Fixed` size in the **Image size** list box.
- **Alignment:** Options include:
 - Auto
 - Right
 - Left
 - CenterOnly PDF and RTF reports support this option.
- **Title:** Specifies a title for the snapshot figure. Options include:
 - Block name: Uses the block name as the title.
 - Full Simulink path name: Uses the Simulink path as the title.
 - Custom: Specifies a custom title.
- **Caption:** Select or enter a short text description for the snapshot figure. Options include:
 - No caption
 - Automatic (use block description). Uses the Simulink block description as the caption.
 - Custom. Specifies a short text description for the snapshot figure.

Scope Snapshot

**Insert
Anything
into
Report?**

Yes. Image.

File Name

rptgen_sl.csl_blk_scope

See Also

Block Loop, Model Loop, Signal Loop, System Loop

Purpose

Run child components for each signal contained in current system, model, or block

Description

The Signal Loop component runs its child components for each signal contained in the current system, model, or block. Its behavior is determined by its parent component. Options include:

- Model Loop: Loops on all signals in the current model.
- System Loop: Loops on all signals in the current system. Choose not to report on the following types of signals by clearing the corresponding option in the **Section options** area:
 - System input signals
 - System output signals
 - System internal signals
- Signal Loop: Loops on the current signal.
- Block Loop : Loops on all signals connected to the current block. Choose not to report on the following types of signals by clearing the corresponding option in the **Section options** area:
 - Block input signals
 - Block output signals
- If the Signal Loop does not have a looping component as its parent, it loops on all signals in all models. Choose not to report on the following types of signals by clearing the corresponding option in the **Section options** area:
 - Block input signals
 - Block output signals
 - System input signals
 - System output signals
 - System internal signals

Signal Loop

Select Signals

- **Include block input signals:** Loops on signals that feed into blocks. This option is valid only when the Block Loop is this component's parent.
- **Include block output signals:** Loops on signals that leave the block. This option is valid only when the Block Loop is this component's parent.
- **Include system input signals:** Loops on signals coming from inports. This option is valid only when the System Loop is this component's parent.
- **Include system internal signals:** Loops on system internal signals. This option is valid only when the System Loop is this component's parent.
- **Include system output signals:** Loops on signals going to outports. This option is valid only when the System Loop is this component's parent.
- **Sort signals:** Specifies how to sort signals:
 - Alphabetically by signal name: Sorts signals alphabetically by name.
 - Alphabetically by signal name (exclude empty): Sorts signals alphabetically by name.
 - Alphabetically by system name: Sorts alphabetically by parent system names. Signals in each system are listed, but in no particular order.
 - By signal depth: Sorts signals by their depth in the model.

Section Options

- **Create section for each object in loop:** Inserts a section in the generated report for each object found in the loop.
- **Display the object type in the section title:** Automatically inserts the object type into the section title in the generated report.
- **Create link anchor for each object in loop:** Creates a hyperlink to the object in the generated report.

**Insert
Anything
into
Report?**

Yes, inserts a section if you select the **Create section for each object in loop** option.

File Name

rptgen_sl.csl_sig_loop

See Also

Block Loop, Model Loop, System Loop

Simulink Automatic Table

Purpose Insert two-column table with information on selected model, system, signal, or block

Description This component inserts a two-column table that contains details for the selected model, system, signal, or block into a generated report.

- Options**
- **Show current:** Includes a specified Simulink software feature in the generated report. Options include:
 - Automatic: Uses the context of the parent loop.
 - Model
 - System
 - Block
 - Annotation
 - Signal
 - **Properties list:** Specifies whether to select properties manually or automatically. Options include:
 - Determine properties automatically: Uses blocks and dialog box properties.
 - Show properties: Enables you to specify properties manually.
 - **Show full path name:** Displays the full path of the selected Simulink model.
 - **Display property names as prompts:** Displays property names as prompts in the generated report. The report includes the dialog box string instead of the underlying code property.
- Display Options**
- **Table title:** Displays a table title in the generated report. Options include:
 - Name: Automatically generates a title from the parameter.
 - Custom: Specifies a custom title.

- No title: Does not include a title.
- **Header row:** Select a header row for the table in the generated report. Options include:
 - No header: Includes no header row.
 - Type and Name: Includes a header row with columns for name and object type.
 - Custom: Includes a custom header.
- **Don't display empty values:** Excludes empty parameters in the generated report.

**Insert
Anything
into
Report?**

Yes. Table.

File Name

rptgen_sl.csl_auto_table

See Also

Block Loop, Model Loop, Signal Loop, System Loop

Simulink Dialog Snapshot

Purpose

Insert snapshots of Simulink editor dialog boxes

Description

This component takes snapshots of Simulink editor dialog boxes. You use it to display the current settings associated with an object or document the appearance of your custom mask dialog boxes.

The behavior of this component is determined by its parent component. Options include:

- **Block Loop:** Documents the current reported block's dialog box.
- **System Loop:** Documents the current reported system's dialog box.

Format

- **Image file format:** Specifies the format for the snapshot image file. The **automatic** format chooses **BMP** format for PDF files, and **PNG** for other formats.
- **Show all tabs:** Automatically generates images for all the tabs for the dialog box. If this check box is cleared, Simulink Report Generator creates an image of only the first tab.

Display Options

- **Scaling:**
 - **Fixed size:** Specifies the number and type of units.
 - **Zoom:** Specifies the percentage, maximum size, and units of measure.
 - **Use image size:** Causes the image to appear the same size in the report as on screen.
- **Size:** Specifies the size of the snapshot in the format **w h** (width height). This field is active only if you choose **Fixed size** from the **Scaling** selection list.
- **Max size:** Specifies the maximum size of the snapshot in the format **w h** (width height). This field is active only if you choose **Zoom** from the **Scaling** selection list.

- **Units:** Specifies the units for the size of the snapshot. This field is active only if you choose **Zoom** or **Fixed** size in the **Image size** list box.
- **Alignment:**
 - Auto
 - Right
 - Left
 - CenterOnly PDF and RTF reports support this option.
- **Title:** Specifies text to appear above the snapshot.
- **Caption:** Specifies text to appear under the snapshot.

Insert Anything into Report?

Yes. Snapshot.

File Name

rptgen_sl.Cdialog boxesnapshot

See Also

Block Loop, System Loop

Simulink Functions and Variables

Purpose Create table that displays workspace variables and MATLAB functions used by reported blocks in Simulink models

Description This component creates a table that displays workspace variables and MATLAB functions used by blocks in a Simulink model. The current model and systems in which the blocks appear are specified in the Model Loop component. For example, a Simulink Gain block might have a string `cos(x)` instead of a number. The Simulink software looks for a variable `x` in the workspace and uses the `cos` function.

Functions

- **Include table of functions:** Includes a table of Simulink functions in the generated report.
- **Table Title:** Specifies a title for the table in the generated report:
 - **Automatic:** Generates a title automatically from the parameter.
 - **Custom:** Specifies a custom title.
- **Parent block:** Includes a column in the table that includes the name of the block, which contains the reported variable.
- **Calling string:** Includes the M-code that calls the reported variable.
- **Include fixed-point functions (sfix, ufix, , ...):** Includes Fixed-Point Toolbox™ functions in the report.

Variables

- **Include table of variables:** Includes a table of Simulink variables in the generated report.
- **Table title:** Specifies a title for the table in the generated report. Options include:
 - **Automatic:** Generates a title automatically from the parameter.
 - **Custom:** Specifies a custom title.
- **Include Workspace I/O parameters:** Reports on variables that contain parameters with time vectors and state matrices. These parameters are set in the **Workspace I/O** pane in the Simulation Parameters dialog box in a Simulink model.

Simulink Functions and Variables

In the following table, if any of the entries in the first column are on, the component looks for the variable listed in the second column. If the component finds the variable in the workspace, it includes it in the report.

Parameter name	Variable name
LoadExternalInput	ExternalInput
SaveTime	TimeSaveName
SaveState	StateSaveName
SaveOutput	OutputSaveName
LoadInitialState	InitialState
SaveFinalState	FinalStateName

- **Parent block:** Includes the name of the block that contains the reported variable.
- **Calling string:** Includes the M-code that calls the reported variable.
- **Size of variable:** Includes the size of the reported variable.
- **Class of variable:** Includes the variable class to which the reported variable belongs.
- **Memory size:** Includes the amount of memory in bytes that the reported variable needs.
- **Value in workspace:** Includes the value of the reported variable.

Very large arrays may appear as [MxN CLASS]. For example, if you have a 300-by-200 double array, it appears in the report as [300x200 DOUBLE].

- **RTW storage class:** Include the storage class of the reported variable.

The title of this column is **Storage Class**. This option looks at the model's `TunableVars` property to see if any of the model variables specify their storage class. If you specify the storage class,

Simulink Functions and Variables

TunableVarsStorageClass and TunableVarsTypeQualifier appear in a table column in the model variables table.

The column entries are TunableVarsStorageClass (TunableVarsTypeQualifier) if TunableVarsTypeQualifier is not empty. If TunableVarsTypeQualifier is empty, the column entry is TunableVarsStorageClass.

Values for TunableVarsStorageClass include:

- Exported Global
 - Auto
 - ImportedExtern
 - ImportedExtern Pointer
- **Data object properties:** Reports on data object properties.

Example

This is an example of a table created by the Model Variables component. This Property Table reports on the variables in the Controller in the F14 demo model.

Variable Name	Parent Blocks	Calling String	Value
Ka	f14/Controller/Gain3	Ka	0.677
Kf	f14/Controller/Gain	Kf	-1.746
Ki	f14/Controller/Proportional plus integral compensator	[Ki]	-3.864
Kq	f14/Controller/Gain2	Kq	0.8156

**Insert
Anything
into
Report?**

Yes. Table.

File Name

rptgen_sl.csl_obj_fun_var

See Also

Block Loop, Model Loop, Signal Loop, System Loop

Simulink Library Information

Purpose Insert table that lists library links in the current model, system, or block

Description This component inserts a table that lists library links in the current model, system, or block.

Table Columns

- **Block:** Includes the Simulink block name in the generated table.
- **Library:** Includes the Simulink library root name in the generated table.
- **Reference block:** Includes the Simulink reference block name in the generated table.
- **Link status:** Includes the link status in the generated table.

Display Options

- **Title:** Specifies a title for the generated report.
- **Sort table by:**
 - **Block:** Sorts the table by block name.
 - **Library:** Sorts the table by library name.
 - **Reference Block:** Sorts the table by reference block name.
 - **Link Status:** Sorts the table by link status.
- **Merge repeated rows:** Merges sorted rows in the generated table.

Example

The following table, which is sorted on the Reference Block column, is generated from the `aero_guidance` model with **Merge repeated rows** deselected.

Block	Library	Reference Block	Status
Equations of Motion (Body Axes)	Aerospace	Equations of Motion (Body Axes)	resolved

Simulink Library Information

Block	Library	Reference Block	Status
Incidence & Airspeed	Aerospace	Incidence & Airspeed	resolved
Fin Actuator	Aerospace	2nd Order Nonlinear Actuator	resolved
3DoF Animation	Aerospace	3DoF Animation	resolved
Atmosphere	Aerospace	Atmosphere model	resolved
Cm	Simulink	Interpolation (n-D) using PreLookup	resolved
Cx	Simulink	Interpolation (n-D) using PreLookup	resolved
Cz	Simulink	Interpolation (n-D) using PreLookup	resolved
Kg	Simulink	Interpolation (n-D) using PreLookup	resolved
Ki	Simulink	Interpolation (n-D) using PreLookup	resolved
Alpha Index	Simulink	PreLookup Index Search	resolved
Mach Index	Simulink	PreLookup Index Search	resolved
Mach Index	Simulink	PreLookup Index Search	resolved
Alpha Index	Simulink	PreLookup Index Search	resolved

When you select **Merge repeated rows**, the generated table collapses rows in the **Block** column so that each row in the **Reference Block** column is unique, as shown in the following table.

Simulink Library Information

Block	Library	Reference Block	Status
Equations of Motion (Body Axes)	Aerospace	Equations of Motion (Body Axes)	resolved
Incidence & Airspeed	Aerospace	Incidence & Airspeed	resolved
Fin Actuator	Aerospace	2nd Order Nonlinear Actuator	resolved
3DoF Animation	Aerospace	3DoF Animation	resolved
Atmosphere	Aerospace	Atmosphere model	resolved
Cm Cx Cz Kg Ki	Simulink	Interpolation (n-D) using PreLookup	resolved
Alpha Index Mach Index Mach Index Alpha Index	Simulink	PreLookup Index Search	resolved

Yes. Table.

**Insert
Anything
Into
Report?**

File Name rptgen_sl.CLibinfo

See Also Block Loop, Model Loop, System Loop

Simulink Linking Anchor

Purpose

Designate locations to which links point

Description

This component designates a location to which links point. This component should have the `Model Loop`, `System Loop`, `Block Loop`, or `Signal Loop` component as its parent.

Properties

- **Insert text:** Specifies text to appear after the linking anchor.
- **Link from current:** Sets the current model, system, block, or signal as the linking anchor. Options include:
 - **Automatic:** Automatically selects the appropriate model, system, block, or signal as a linking anchor. If the `Model Loop` component is the parent component, the linking anchor is set on the current model. Similarly, if the `Block Loop` or `Signal Loop` is the parent component, the linking anchor is inserted for the current system, block, or signal, respectively.
 - **Model:** Sets the linking anchor to the current model.
 - **System:** Sets the linking anchor to the current system.
 - **Block:** Sets the linking anchor to the current block.
 - **Annotation:** Sets the linking anchor to the current annotation.
 - **Signal:** Sets the linking anchor to the current signal.

Note Each object should have only one anchor per report. For more information, see the `Simulink Summary Table` component reference page.

Insert Anything into Report?

Yes. A link, and possibly text, depending on attribute choices.

File Name rptgen_sl.cs1_obj_anchor

See Also Block Loop, Model Loop, Signal Loop, System Loop

Simulink Name

Purpose Insert name of a Simulink model, system, block, or signal into report

Description This component inserts the name of a Simulink model, system, block, or signal into the report.

You can use this component as the first child component of a Chapter/Subsection component, which allows the current Simulink model, system block, or signal name to be the chapter or section title.

Properties

- **Object type**
 - **Automatic:** Automatically selects the appropriate model, system, block, or signal name as the Simulink object name to include in the report. If the Model Loop component is the parent component, the object name is the current model name. Similarly, if the System Loop, Block Loop, or Signal Loop is the parent component, then the object name is the name of the current system, block, or signal, respectively.
 - **Model:** Includes the current model name in the report.
 - **System:** Includes the current system name in the report.
 - **Block:** Includes the current block name in the report.
 - **Signal:** Includes the current signal name in the report. If the signal name is empty, the signal <handle>, which is a unique numerical identifier to that signal, appears in the report.
 - **Annotation:** Includes the current annotation name in the report.
- **Display name as:** Display the Simulink object name in the report. Options include:
 - **Name:** For example, f14
 - **Type Name:** For example, Model f14
 - **Type - Name:** For example, Model - f14
 - **Type: Name:** For example, Model: f14

- **Show full path name:** Displays the full path of a system or block. Choosing this option for a block causes the Simulink block name to appear as <Model Name>/<System Name>/<Block Name>.

Note This option is not available for models or signals.

**Insert
Anything
into
Report?**

Yes. Text.

File Name

rptgen_sl.csl_obj_name

See Also

Chapter/Subsection

Simulink Property

Purpose Insert property name/property value pair for current Simulink model, system, block, or signal

Description This component inserts a single property name/property value pair for the current Simulink model, system, block, or signal.

Simulink Object and Parameter

- **Object type:** Specifies the Simulink object type to include in the report. Options include:
 - System
 - Model
 - Block
 - Signal
 - Annotation
- **System parameter name:** Specifies a Simulink parameter name to include in the generated report:
 - If you select **Model** for **Object type**, this option appears as **Model parameter name**.
 - If you select **Block** for **Object type**, this option appears as **Block parameter name**.
 - If you select **Signal** for **Object type**, this option appears as **Signal parameter name**.

Display Options

- **Title:** Choose a title to display in the generated report:
 - **Automatic:** Uses the parameter name as the title.
 - **Custom:** Specifies a custom title.
 - **None:** Uses no title.
- **Size limit:** Limits the width of the display in the generated report. Units are in pixels. The size limit for a given table is equal to the hypotenuse of the table width and height [$\sqrt{w^2+h^2}$]. The size limit for text is the number of characters squared. If you exceed the

size limit, the variable appears in condensed form. Setting a size limit of zero always causes the variable to display, regardless of its size

- **Display as:** Specifies a display style. Options include:
 - **Auto table/paragraph:** Displays as a table or paragraph based on the information.
 - **Table:** Displays as a table.
 - **Paragraph:** Displays as a text paragraph.
 - **Inline text:** Displays as inline, which fits in line with the surrounding text.
- **Ignore if value is empty:** Excludes the parameter from the generated report if the parameter is empty.

Insert Anything into Report?

Yes. Text.

File Name

rptgen_sl.csl_property

See Also

Block Loop, Model Loop, System Loop

Simulink Property Table

Purpose Insert table that reports on model-level property name/property value pairs

Description This component inserts a table that reports on model-level property name/property value pairs.

Properties **Select Object:** Choose the object for the Property Table in the generated report. Options include:

- Model
- System
- Block
- Signal
- Annotation

For more information about selecting object types in Property Table components, see “Selecting Object Types” on page 5-12.

Table Select a preset table, which is already formatted and set up, in the preset table list in the upper-left corner of the attributes page.

- **preset table:** Specifies the type of the object property table. Options include:
 - Default
 - Simulation parameters
 - Version information
 - RTW information
 - Summary (req. RTW)
 - Blank 4x4

To apply a preset table, select the table and click **Apply**.

- **Split property/value cells:** Split property name/property value pairs into separate cells. For the property name and property value to appear in adjacent horizontal cells, select the **Split property/value cells** check box. In this case, the table is in split mode, so only one property name/property value pair is allowed per cell. If there is more than one name/property pair in a cell, only the first pair appears in the report. All subsequent pairs are ignored.

For the property name and property value to appear together in one cell, clear the **Split property/value cells** check box. This is nonsplit mode. Nonsplit mode supports more than one property name/property value pair and text per cell.

Before switching from nonsplit mode to split mode, make sure that there is only one property name/property value pair per table cell. If there is more than one property name/property value pair or text per cell, only the first property name/property value pair appears in the report; subsequent pairs and text are omitted.

- **Display outer border:** Displays the outer border of the table in the generated report.
- **Table Cells:** Specifies table properties to modify. The selection in this pane affects available fields in the **Cell Properties** pane.

Cell Properties

The options in this pane depend on the object selected in the **Table Cells** pane. If you select %<Name> Information, only **Contents** and **Show** appear. If you select any other object in the **Table Cells** pane, **Lower border** and **Right border** display.

- **Contents:** Enables you to change the contents of the table cell selected in the **Table Cells** pane.
- **Show as:** Specifies the format for the contents of the table cell. Options include:
 - Value
 - Property Value
 - PROPERTY Value

Simulink Property Table

- Property: Value
- PROPERTY: Value
- Property - Value
- PROPERTY - Value
- **Alignment:** Specifies the alignment of the contents of the selected table cell in the **Table Cells** pane. Options include:
 - Left
 - Center
 - Right
 - Double justified
- **Lower border:** Displays the lower border of the table in the generated report.
- **Right border:** Displays the right border of the table in the generated report.

Creating Custom Tables

To create a custom table, edit a preset table, such as the **Blank 4x4** table. Add and delete rows and add properties. To open the **Edit Table** dialog box, click **Edit**.

For more information on creating custom property tables, see “Working with Property Table Components” on page 5-9.

If the Real-Time Workshop software is not installed, **Summary (req RTW)** does not appear in this list. If you are using a report template that contains a summary property, the property name appears in the report, but the property value does not.

Example

The following report displays information on the F14 demo model using the **Simulation Parameters** preset table.

Simulink Property Table

<i>Solver</i> ode45	<i>ZeroCross</i> on	<i>StartTime</i> 0.0 <i>StopTime</i> 60
<i>RelTol</i> 1e-4	<i>AbsTol</i> 1e-6	<i>Refine</i> 1
<i>InitialStep</i> auto	<i>FixedStep</i> auto	<i>MaxStep</i> auto
<i>LimitMaxRows</i> off	<i>MaxRows</i> 1000	<i>Decimation</i> 1

Insert Anything into Report?

Yes. Table.

File Name

rptgen_sl.csl_prop_table

See Also

Model Loop, Signal Loop, System Loop

Simulink Sample Time

Purpose	Insert title of Simulink sample time into report
Description	This component inserts a title for a Simulink sample time into the report.
Properties	<ul style="list-style-type: none">• Table Options<ul style="list-style-type: none">▪ Title: Specifies a title for the table in the generated report.▪ Grid lines: If checked, display grid lines in the report.
Insert Anything into Report?	Yes. Table.
File Name	rptgen_sl.CSampleTime
See Also	Chapter/Subsection

Purpose	Display properties or parameters of specified Simulink models, systems, blocks, or signals in table
Description	This component displays properties or parameters of selected Simulink models, systems, blocks, or signals in a table.
Object type	<p>Choose the object type to display in the generated report. Options include:</p> <ul style="list-style-type: none">• Block (Default)• Model• System• Signal• Annotation <p>The selected object type affects the options available in the Property Columns pane.</p>
Table title	<p>Choose a title to appear in the generated report:</p> <ul style="list-style-type: none">• Automatic: Automatically generates a title from the parameter.• Custom: Specifies a custom title.
Property Columns	<p>This pane displays object properties to include in the Summary Table in the generated report.</p> <ul style="list-style-type: none">• To add a property:<ol style="list-style-type: none">1 select the appropriate property level in the text box on the left.2 In the text box on the right, select the property that you want to add and click Add.• To delete a property, select the property name and click Delete.

Simulink Summary Table

%<SplitDialogParameters> is a unique property that can be specified for Simulink Summary Tables where the object type is **Block**. This property generates multiple summary tables, organized by block type. Each Summary Table group contains the dialog box parameters for that block.

Some entries in the list of available properties (such as **Depth**) are “virtual” properties that you cannot access using the `get_param` command. The properties used for property/value filtering in the block and System Loop components must be retrievable by the `get_param`. Therefore, you cannot configure your Summary Table to report on all blocks of `Depth == 2`.

You can create multiple values for a property in a Simulink Summary Table. For example, to report on blocks of type **Inport**, **Outputport** and **Constant**:

- 1 Check the **Search for Simulink property name/property value pairs** box.
- 2 Make sure that you set **Property Name** to **BlockType**.
- 3 Type the following text into the **Property Value** field:

```
\<(Inport|Outputport|Constant)\>
```

Remove empty columns: Removes empty columns from the table.

Object Rows

- **Insert anchor for each row:** Inserts an anchor for each row in the summary table.
- **Report On:** Options include:
 - **Automatic list from context:** Reports on all blocks in the current context, as set by the parent component.

Loop Options

- Custom - use `block list`: Reports on a list of specified blocks. Specify the full path of each block.
- **Sort blocks**
 - Alphabetically by block name: Sorts blocks alphabetically by name.
 - Alphabetically by system name: Sorts systems alphabetically by name. Blocks in each system are listed, but in no particular order.
 - Alphabetically by full Simulink path: Sorts blocks alphabetically by Simulink path.
 - By block type: Sorts blocks alphabetically by block type.
 - By block depth: Sorts blocks by their depth in the model.
 - By traversal order: Sorts blocks by traversal order.
 - By simulation order: Sorts blocks by execution order.
 - `%<VariableName>`: Inserts the value of a variable from the MATLAB workspace. The `%<>` notation can denote a string or cell array. For more information, see `%<VariableName>` Notation on the Text component reference page.
- **Search for Simulink property name/property value pairs:**
Reports on blocks with specified property name/property value pairs.

Example

Specify the following options to generate a Summary Table in a report for on the demo model F14:

- Sort on systems by system depth.
- Include the system parameters `Name` and `Block` in the table.

The following table appears in the report.

Simulink Summary Table

Name	Blocks
f14	u, Actuator Model, Aircraft Dynamics Model, Angle of Attack, Controller, Dryden Wind Gust Models, Gain, Gain1, Gain2, Gain5, More Info, More Info1, Nz pilot calculation, Pilot, Pilot G force Scope, Stick Input, Sum, Sum1, alpha (rad), Nz Pilot (g)
Aircraft Dynamics Model	Elevator Deflection d (deg), Vertical Gust wGust (ft/sec), Rotary Gust qGust (rad/sec), Gain3, Gain4, Gain5, Gain6, Sum1, Sum2, Transfer Fcn.1, Transfer Fcn.2, Vertical Velocity w (ft/s), Pitch Rate q (rad/s)
Controller	Stick Input (in), alpha (rad), q (rad/s), Alpha-sensor Low-pass Filter, Gain, Gain2, Gain3, Pitch Rate Lead Filter, Proportional plus integral compensator, Stick Prefilter, Sum, Sum1, Sum2, Elevator Command (deg)
Dryden Wind Gust Models	Band-Limited White Noise, Q-gust model, W-gust model, Wg, Qg
More Info	None
More Info1	None
Nz pilot calculation	w, q, Constant, Derivative, Derivative1, Gain1, Gain2, Product, Sum1, Pilot g force (g)

Insert Anything into Report?

Yes. Table.

File Name

rptgen_sl.cs1_summ_table

See Also

Block Loop, Model Loop, Signal Loop, System Loop

Purpose	Run child components for all states in current context
Description	<p>This component runs its children for all states in its context, which is determined by its parent component. Options include:</p> <ul style="list-style-type: none">• Model Loop: Includes all states in the models.• System Loop: Includes all states in the systems.• Machine Loop: Includes all states in the machines.• Chart Loop: Includes all states in the charts.• State Loop: Includes all states in the current state.
State Types	<ul style="list-style-type: none">• Include “and” and “or” states: Includes AND and OR states in the loop.• Include “box” states: Includes “box” states in the loop.• Include functions: Includes “function” states in the loop.• Include truth tables: Includes truth tables in the loop.• Include Embedded MATLAB functions: Includes Embedded MATLAB functions in the loop.
Loop Options	<ul style="list-style-type: none">• Report depth: Specifies the level on which to loop. Options include:<ul style="list-style-type: none">▪ Local children only▪ All objects• Skip autogenerated charts under truth table: Keeps autogenerated state objects under truth tables from appearing in the report.• Search Stateflow: Indicates specific states to include in the loop.

State Loop

Section Options

- **Create section for each object in loop:** Inserts a section in the generated report for each object found in the loop.
- **Display the object type in the section title:** Inserts the object type automatically into the section title in the generated report.
- **Create link anchor for each object in loop:** Creates a hyperlink to the object in the generated report.

Insert Anything into Report?

Yes, section, if you select the **Create section for each object in loop** option.

File Name

rptgen_sf.csf_state_loop

See Also

Chart Loop, Machine Loop, Model Loop, State Loop, System Loop

Purpose

Insert table with properties of current Stateflow object

Description

The Stateflow Automatic Table component inserts a table that contains the properties of the current Stateflow object. Parents of this component can be:

- Machine Loop
- State Loop
- Chart Loop
- Graphics Object Loop

Display Options

- **Table title:** Specifies a title for the table in the generated report. Options include:
 - No title: Includes no title.
 - Custom: Includes a custom title.
 - Name (default): Uses an object name as the title. Options include:
 - Object name
 - Object name with Stateflow path
 - Object name with Simulink and Stateflow path
- **Header row:** Selects a header row for the table in the generated report. Options include:
 - No header: Includes no header row.
 - Type and Name: Includes a header row with columns for name and object type. When selected, this option creates a header row for the table with object name and type.
 - Custom: Includes a custom header.
- **Don't display empty values:** Excludes empty values from the generated report.

Stateflow Automatic Table

**Insert
Anything
into
Report?**

Yes. Table.

File Name

rptgen_sf.csf_auto_table

See Also

Chart Loop, Graphics Object Loop, Machine Loop, State Loop

Purpose	Count number of Stateflow objects in current context
Description	This component counts the number of Stateflow objects in the current context.
Properties	<ul style="list-style-type: none">• Search depth: Specifies the search depth for the count. Options include:<ul style="list-style-type: none">▪ Immediate children only (default): Searches only children one level under the Stateflow object.▪ All descendants: Searches all children of the Stateflow object.• Sort results: Specifies the sort method for the count results. Options include:<ul style="list-style-type: none">▪ Numerically decreasing by object count (Default)▪ Alphabetically increasing by object type• Include a list of objects in table: Inserts a column containing the counted objects.• Show total count: Displays a total of counted objects.
Insert Anything into Report?	Yes. Table.
File Name	rptgen_sf.csf_count
See Also	State Loop

Stateflow Dialog Snapshot

- Purpose** Insert snapshots of Stateflow editor dialog boxes
- Description** This component reports on the current reported Stateflow dialog box object, depending on its context. If this component is the child of a State Loop, for example, the report includes information about the current State's dialog box. Display the current settings associated with an object or document the appearance of your custom mask dialog boxes.
- Format**
- **Image file format:** Specifies the format for the snapshot image file. The Automatic format uses BMP format for PDF files and PNG for other formats.
 - **Show all tabs:** Automatically generates images for all the tabs for the dialog box. If this check box is cleared, the Simulink Report Generator software creates an image of only the first tab.
- Display Options**
- **Scaling:** Options include:
 - **Fixed size:** Specifies the number and type of units.
 - **Zoom:** Specifies the percentage, maximum size, and units of measure.
 - **Use image size:** Causes the image to appear the same size in the report as on screen.
 - **Size:** Specifies the size of the snapshot in the form `w h` (width height). This field is active only if you choose **Fixed size** in the **Scaling** selection list.
 - **Max size:** Specifies the maximum size of the snapshot in the form `w h` (width height). This field is active only if you choose **Zoom** in the **Scaling** selection list.
 - **Units:** Specifies the units for the size of the snapshot. This field is active only if you choose **Zoom** or **Fixed size** in the **Image size** list box.
 - **Alignment:** Aligns your snapshot. Options include:
 - Auto

- Right
- Center
- Left

Only PDF and RTF reports support this option.

- **Title:** Specifies text to appear above the snapshot.
- **Caption:** Specifies text to appear under the snapshot.

Insert Anything into Report?

Yes. Snapshot.

File Name

rptgen_sl.Cdialog boxesnapshot

See Also

State Loop

Stateflow Filter

Purpose	Run child components only if current object type matches specified object type
Description	This component runs its children only if the current object type, as set by its parent Stateflow Hierarchy Loop, matches the selected object type.
Properties	<ul style="list-style-type: none">• Object type: Specifies the Stateflow object type to include in the report.• Run only if Stateflow object has at least the following number of Stateflow children: Specifies a minimum number of children that a Stateflow object must have to include in the report.• Automatically insert linking anchor: Inserts a linking anchor before the reported object. If an anchor for this object exists, a second anchor is not created.
Insert Anything into Report?	No.
File Name	rptgen_sf.csf_obj_filter
See Also	Stateflow Hierarchy Loop

Purpose	Provide visual representation of the hierarchy of a Stateflow object
Description	This component inserts a tree that shows the hierarchy of a given Stateflow object.
Tree Options	<ul style="list-style-type: none">• Construct tree from: Specifies the object to use for the tree representation. Options include:<ul style="list-style-type: none">▪ Current object▪ Root of current object: Starts reporting from the top of the hierarchy.• Emphasize current object in tree: Highlights the current object in the tree representation.• Show number of parents: Specifies the number of parents to include in the tree representation.• Show siblings: Displays siblings in the tree representation.• Show children to depth: Specifies the depth of children to display for each object in the tree representation.
Children	<ul style="list-style-type: none">• Show junctions: Specifies the level of junction detail to display in the generated report. Options include:<ul style="list-style-type: none">▪ All▪ Non-redundant▪ None• Show transitions: Specifies the level of transition detail to display in the generated report. Options include:<ul style="list-style-type: none">▪ All▪ Labeled or non-redundant▪ Non-redundant▪ Labeled

Stateflow Hierarchy

List Formatting

- None
- **Skip autogenerated charts under truth tables:** Excludes autogenerated charts under truth tables.
- **List style:** Options include:
 - Bulleted list
 - **Numbered list:** Allows you to specify numbering options in the **Numbering style** section.
 - **Numbering style:** Allows you to specify a numbering style. This setting is supported only in the RTF/DOC report format.
Options include:
 - 1,2,3,4...
 - a,b,c,d...
 - A,B,C,D...
 - i,ii,iii,iv...
 - I,II,III,IV...To show the parent number in each list entry, select **Show parent number in nested list (1.1.a)**. To show only the current number or letter, select **Show only current list value (a)**.

Insert Anything into Report?

Yes. Tree graphic.

File Name

rptgen_sf.csf_hier

See Also

Stateflow Hierarchy Loop

Purpose	Run child components on Stateflow object hierarchy
Description	This component runs its child components on the Stateflow object hierarchy.
Loop Options	<ul style="list-style-type: none">• Minimum legible font size: Specifies the minimum font size to use in the report. The default font size, 8, is the smallest recommended font size.• Skip autogenerated charts under truth tables; Excludes autogenerated charts under truth tables in the report.• Search Stateflow: Reports on Stateflow charts with specified property name/property value pairs.
Section Options	<ul style="list-style-type: none">• Create section for each object in loop: Inserts a section in the generated report for each object found in the loop.• Display the object type in the section title: Inserts the object type automatically into the section title in the generated report.• Create link anchor for each object in loop: Creates a hyperlink to the object in the generated report.
Insert Anything into Report?	No.
File Name	rptgen_sf.csf_hier_loop
See Also	Stateflow Hierarchy

Stateflow Linking Anchor

Purpose	Designate locations to which links point
Description	<p>This component designates a location to which other links point. The linking anchor is set to the current object, as defined by the parent component.</p> <p>This component must have the <code>Chart Loop</code>, <code>State Loop</code>, <code>Machine Loop</code>, or <code>Stateflow Filter</code> component as its parent.</p>
Properties	Insert text: Specifies text to appear after the linking anchor.
Insert Anything into Report?	Yes. A link, and possibly text, depending on attribute choices.
File Name	<code>rptgen_sf.csf_obj_anchor</code>
See Also	<code>Chart Loop</code> , <code>Machine Loop</code> , <code>State Loop</code> , <code>Stateflow Filter</code> ,

Purpose	Insert into report name of Stateflow object specified by parent component
Description	<p>This component inserts the name of the Stateflow object, as defined by its parent component, into the report. This component must have the State Loop, Chart Loop, or Stateflow Filter component as its parent.</p> <p>You can use this component as the first child component of a Chapter/Subsection component to allow the current Stateflow object name to be the chapter or section title.</p>
Properties	<ul style="list-style-type: none">• Display name as: Displays the Stateflow object name in the report. Options include:<ul style="list-style-type: none">▪ Name: For example, Object▪ Type Name: For example, Object <ObjectName>▪ Type - Name: For example, Object - <ObjectName>▪ Type: Name: For example, Object: <ObjectName>• Display name as: Specifies the level of detail with which the Stateflow object name displays the report. Options include:<ul style="list-style-type: none">▪ Object name▪ Object name with Stateflow path▪ Object name with Simulink and Stateflow path
Insert Anything into Report?	Yes. Text.
File Name	rptgen_sf.csf_obj_name
See Also	Chapter/Subsection, Chart Loop, State Loop, Stateflow Filter

Stateflow Property

Purpose Insert into report table, text, or paragraph with information on selected Stateflow object property

Description This component inserts a table, text, or paragraph that contains details of the selected Stateflow object property.

Property to Display **Property name:** Specifies the Stateflow property name to display.

Display Options

- **Title:** Specifies a title to display in the generated report. Options include:
 - **Automatic:** Uses the parameter name as the title.
 - **Custom:** Specifies a custom title.
 - **None:** Specifies no title.
- **Size limit:** Specifies the width of the display in the generated report. Units are in pixels. The size limit for a given table is the hypotenuse of the table's width and height, $\sqrt{w^2+h^2}$. The size limit for text is the number of characters squared. If you exceed the size limit, the variable appears in condensed form.

Setting a size limit of 0 always displays the variable in long form, regardless of its size.

- **Display as:** Specifies a display style from the menu. Options include:
 - **Auto table/paragraph (default):** Displays as a table or paragraph based on the information.
 - **Table:** Displays as a table.
 - **Paragraph:** Displays as a text paragraph.
 - **Inline text:** Displays in line with the surrounding text.
- **Ignore if value is empty:** Excludes empty parameters from the generated report.

**Insert
Anything
into
Report?**

Yes. Text, paragraph, or table.

File Name

rptgen_sf.csf_property

See Also

Paragraph, Table, Text, Stateflow Name

Stateflow Property Table

Purpose	Insert into report property-value table for Stateflow object
Description	<p>This component inserts a property-value table for a Stateflow object into the report. This component's parent must be <code>Stateflow Filter</code>.</p> <p>For more information on working with Property Table components, see “Working with Property Table Components” on page 5-9.</p>
Table	<p>Select a preset table, which is already formatted and set up, in the preset table list in the upper-left corner of the attributes page.</p> <ul style="list-style-type: none">• preset table: Specifies a type of table to display the object property table. Options include:<ul style="list-style-type: none">▪ Default▪ Machine▪ Chart▪ State▪ Truth table▪ EM function▪ Data▪ Event▪ Junction<p>To apply a preset table, select the table and click Apply.</p>• Split property/value cells: Splits property name/property value pairs into separate cells.<ul style="list-style-type: none">▪ For the property name and property value to appear in adjacent horizontal cells, select the Split property/value cells check box. In this case, the table is in split mode, so only one property name/property value pair is allowed per cell. If there is more than one name/property pair in a cell, only the first pair appears in the report. All subsequent pairs are ignored.

- For the property name and property value to appear together in one cell, clear the **Split property/value cells** check box. This is nonsplit mode. Nonsplit mode supports more than one property name/property value pair and text.
- Before switching from nonsplit mode to split mode, make sure that there is only one property name/property value pair per table cell. If there is more than one property name/property value pair or any text in a given cell, only the first property name/property value pair appears in the report. Subsequent pairs and text are omitted.
- **Display outer border:** Displays the outer border of the table in the generated report.
- **Table Cells:** Specifies table properties to modify. The selection in this pane affects the available fields in the **Cell Properties** pane.

Cell Properties

The options in the **Title Properties** pane depend on the object selected in the **Table Cells** pane. If you select %<Name>, only **Contents** and **Show** appear. If you select any other object in the **Table Cells** pane, **Lower border** and **Right border** appear.

- **Contents:** Modifies the contents of the table cell selected in the **Table Cells** pane.
- **Alignment:** Justifies the contents of the selected table cell in the **Table Cells** pane. Options include:
 - Left
 - Center
 - Right
 - Double justified
- **Show As:** Specifies the format for the contents of the table cell. Options include:
 - Value
 - Property Value

Stateflow Property Table

- PROPERTY Value
 - Property: Value
 - PROPERTY: Value
 - Property - Value
 - PROPERTY - Value
- **Lower border:** Displays the lower border of the table in the generated report.
 - **Right border:** Displays the right border of the table in the generated report.

Creating Custom Tables

You can edit a preset table, such as the Blank 4x4 table, to create a custom table. Add and delete rows and add properties. To open the Edit Table dialog box, click **Edit**.

For details about creating custom property tables, see “Working with Property Table Components” on page 5-9.

Insert Anything into Report?

Yes. Table.

File Name

rptgen_sf.csf_prop_table

See Also

Stateflow Filter

- Purpose** Insert into report snapshot of Stateflow object
- Description** This component inserts a snapshot of a Stateflow object, defined by the Stateflow Filter parent component, into the report.
- This component only executes if the selected object in the Stateflow Filter component is a graphical object, such as Chart, State, Transition, and Frame.
- Snapshot**
- **Image file format:** Specifies the image file format (for example, JPEG or TIFF). Select Automatic SF Format (default) to automatically choose the format best suited for the specified report output format. Otherwise, choose an image format that your output viewer can read. Options include:
 - Automatic SF Format (uses the file format selected in the Preferences dialog box)
 - Adobe Illustrator
 - Bitmap (16m-color)
 - Bitmap (256-color)
 - Black and white encapsulated PostScript
 - Black and white encapsulated PostScript (TIFF)
 - Black and white encapsulated PostScript2
 - Black and white encapsulated PostScript2 (TIFF)
 - Black and white PostScript
 - Black and white PostScript2
 - Color encapsulated PostScript
 - Color encapsulated PostScript (TIFF)
 - Color encapsulated PostScript2
 - Color encapsulated PostScript2 (TIFF)
 - Color PostScript

Stateflow Snapshot

- Color PostScript2
- JPEG high quality image
- JPEG medium quality image
- JPEG low quality image
- PNG 24-bit image
- Scalable vector graphics (SVG)
- TIFF - compressed
- TIFF - uncompressed
- Windows metafile
- **Paper orientation:** Options include:
 - Portrait
 - Landscape
 - Rotated
 - Largest dimension vertical. Positions the image so that its largest dimension is vertical.
 - Use Chart PaperOrientation setting. Uses the paper orientation setting you have specified for your chart.
- **Image sizing:** Options include:
 - Shrink image to minimum font size specified in Stateflow Hierarchy Loop: Resizes the image so that the text label font size is the minimum font size.
 - Fixed and Zoom: Specifies the size of the image.
- **Scaling:** Specifies a percentage of the image's size to which to scale it.
- **Maximum size:** Specifies the maximum size for the snapshot in the generated report in the selected units. Use [width height] format. In the units text box, select Inches, Centimeters, Points, or Normalized.

- **Use `printframe`:** Inserts a frame around your image. Use the default frame or create a custom one.
- **Use `printframe paper settings`:** Uses the dimensions and parameters as set by the specified `printframe` to size your image. If you choose this option, all other options (except for **Image file format**) become inactive.

Properties

- **Include callouts to describe visible objects:** Displays descriptive callouts for visible objects.
- **Insert anchors for transitions and junctions:** Inserts anchors for transitions and junctions into the report. Options include:
 - None
 - Redundant children only
 - All
- **Run only if Stateflow object has at least the following number of children:** Specifies the minimum number of children that the current Stateflow object must have to include in the report. This option is inactive unless the selected object in the parent Stateflow Filter component is a graphical object.

Tip This option allows you to exclude certain images to decrease the size of the report for large models.

Display Options

- **Scaling:** Options include:
 - **Use image size:** Uses the image size that you specify in the snapshot option.
 - **Zoom and Fixed size:** Allows you to specify the size of the image.
- **Size:** Specifies a size in inches for your image. The default is 7-by-9.

Stateflow Snapshot

- **Max size:** Specifies the maximum size of the snapshot in the format `w h` (width height). This field is active only if you choose **Zoom** from the **Scaling** selection list.
- **Units:** Specifies the units for the size of the snapshot. This field is active only if you choose **Zoom** or **Fixed size** in the **Image size** list box.
- **Alignment:** Options include:
 - Auto
 - Right
 - Center
 - LeftOnly PDF and RTF reports support this option.
- **Image title:** Options include:
 - None(Default).
 - Object name: Uses the object name as the title.
 - Full Stateflow name: Specifies the Stateflow path and the name of the object.
 - Full Simulink + Stateflow name: Specifies the Simulink path and name of the object.
 - Custom: Enter a different title.
- **Caption:** Specifies a caption for your image. Options include:
 - None(Default).
 - Custom: Specifies a custom caption.
 - Description: Sets the caption to the value of the object Description property.

**Insert
Anything
into
Report?**

Yes. Image.

File Name

rptgen_sf.csf_obj_snap

File Name

rptgen_sf.csf_prop_table

See Also

Stateflow Filter

Stateflow Summary Table

Purpose	Display table of properties or parameters of specified Stateflow object
Description	<p>This component displays a table of properties or parameters of specified Stateflow objects. It can have the following parents:</p> <ul style="list-style-type: none">• Any Stateflow looping component• Any Simulink looping component (Model Loop, System Loop, Block Loop, or Signal Loop)
Properties	<ul style="list-style-type: none">• Object type: Specifies the object type to display in the generated report. This value affects the options available in the Property Columns pane.• Table title: Specifies a title for the Summary Table in the generated report. Options include:<ul style="list-style-type: none">▪ Automatic: Generates a title automatically from the parameter.▪ Custom: Specifies a custom title.
Property Columns	<ul style="list-style-type: none">• Property columns: Displays the object properties to include in the Summary Table in the generated report.<ul style="list-style-type: none">▪ To add a property:<ul style="list-style-type: none">• Select the appropriate property level in the text box.• In the context list under the text box, select the property that you want to add and click Add.▪ To delete a property, select the property name and press the Delete key. <p>Some entries in the list of available properties (such as <code>Depth</code>) are “virtual” properties that you cannot access using the <code>get_param</code> command. The properties used for property/value filtering in the block and System Loop components must be retrievable by the <code>get_param</code>. Therefore, you cannot configure your Summary Table to report on all blocks of <code>Depth == 2</code>.</p>

- **Remove empty columns:** Removes empty columns from the Summary Table in the generated report.

Object Rows

Insert anchor for each row: Inserts an anchor for each row in the summary table.

Report On

- **Automatic list from context:** Reports on all blocks in the current context, as set by the parent component.
- **Custom - use block list:** Reports on a specified list of blocks. Specify the full path of each block.

Loop Options

Choose block sorting options and reporting options in this pane.

- **Sort blocks:** Specifies how to sort blocks:
 - **Alphabetically by block name:** Sorts blocks alphabetically by name.
 - **Alphabetically by system name:** Sorts systems alphabetically by name. Blocks in each system are listed, but in no particular order.
 - **Alphabetically by full Simulink path:** Sorts blocks alphabetically by Simulink path.
 - **By block type:** Sorts blocks alphabetically by block type.
 - **By block depth:** Sorts blocks by their depth in the model.
 - **By traversal order:** Sorts blocks by traversal order.
 - **By simulation order:** Sorts blocks by execution order.
 - **%<VariableName>:** Inserts the value of a variable from the MATLAB workspace. The %<> notation can denote a string or cell array. For more information, see %<VariableName> Notation on the Text component reference page.
- **Search for Simulink property name/property value pairs:** Reports on blocks with specified property name/property value pairs.

Stateflow Summary Table

- **Search Stateflow:** Reports on Stateflow charts with specified property name/property value pairs.

**Insert
Anything
into
Report?**

Yes. Table.

File Name

rptgen_sf.csf_summ_table

See Also

Block Loop, Chart Loop, Model Loop, Object Loop, Signal Loop, State Loop, Stateflow Hierarchy Loop, System Loop

Purpose	Run child components only if the current system meets specified conditions
Description	This component runs child components only if the current system meets specified conditions.
Properties	<ul style="list-style-type: none">• Report only if system has at least N blocks: Specifies the minimum number of blocks that the system must include for the child components to execute. If you enter 0, child components execute regardless of the number of blocks in the system.• Report only if system has at least N subsystems: Specifies the minimum number of subsystems that the system must include for the child components to execute Note that if you enter 0, child components execute regardless of the number of subsystems in the system.• Report only if system mask type is: Specifies which masks to include in the generated report. Options include:<ul style="list-style-type: none">▪ Either masked or unmasked▪ Masked▪ Unmasked
Insert Anything into Report?	No.
File Name	rptgen_sf.csf_obj_filter
See Also	System Loop

System Hierarchy

Purpose

Create nested list that shows hierarchy of specified system

Description

This component creates a nested list that shows the hierarchy of a specified system. The list can display all systems in a model, or the parents and children of the current system.

Starting System

- **Build list from:** Specifies the system or model from which the list is built. Options include:
 - Current system
 - Current model
- **Emphasize current system:** Highlights the current system or model in the generated report.

Display Systems

- **Show number of parents:** Specifies the number of parents to list.
- **Display peers of current system:** Shows the current system's peers in the generated report.
- **Show children to depth:** Specifies the depth of children to list.

List Formatting

- **List style:** Options include:
 - Bulleted list
 - Numbered list: Allows you to select numbering options in the **Numbering style** section.
- **Numbering style:** Allows you to select a numbering style in the selection list, if you set **List style** to Numbered List. This setting is supported only in the RTF/DOC report format.

Options include:

- 1,2,3,4,...
- a,b,c,d,...
- A,B,C,D,...
- i,ii,iii,iv,...

- I, II, III, IV, ...

**Insert
Anything
into
Report?**

Yes. List.

File Name

rptgen_sl.csl_sys_list

See Also

Model Loop, System Loop

System Loop

Purpose Specify systems and subsystems on which to loop, as defined by parent component

Description This component runs its child components for each system defined by the parent component. For example, you can include this component as the child of a `Model Loop` component to include systems and subsystems within a given model in the report.

Report On

- **Loop on Systems:**
 - **Select systems automatically:** Reports on all systems in the current context as set by the parent component. Options include:
 - `Model Loop`: Reports on systems in the current model.
 - `System Loop`: Reports on the current system.
 - `Signal Loop`: Reports on the current signal's parent system.
 - `Block Loop`: Reports on the current block's parent system.If this component does not have any of these components as its parent, selecting this option reports on all systems in all models.
- **Custom - use system list:** Reports on a list of specified systems. Specify the full path of each system.
- `%<VariableName>`: Inserts the value of a variable from the MATLAB workspace. The `%<>` notation can denote a string or cell array. For more information, see `%<VariableName> Notation on the Text component reference page`.

Loop Options

- **Sort Systems:** Specifies how to sort systems. Options include:
 - **Alphabetically by system name (default):** Sorts systems alphabetically by name.
 - **By number of blocks in system:** Sorts systems by number of blocks. The list shows systems by decreasing number of blocks; that is, the system with the largest number of blocks appears first in the list.

- By system depth: Sorts systems by their depth in the model.
- By traversal order: Sorts systems in the order they are traversed.
- **Search for:** Reports only on blocks with specified property name/property value pairs.

Section Options

- **Create section for each object in loop:** Inserts a section in the generated report for each object found in the loop.
- **Display the object type in the section title:** Inserts the object type automatically into the section title in the generated report.
- **Number sections by system hierarchy:** Hierarchically numbers sections in the generated report.
- **Create link anchor for each object in loop:** Creates a hyperlink to the object in the generated report.

Examples

For an example of how to use this component with a Model Loop as its parent, see Model Loop.

Insert Anything into Report?

Yes, inserts a section if you select the **Create section for each object in loop** option.

File Name

rptgen_sl.csl_sys_loop

See Also

Block Loop, Model Loop, Signal Loop, System Loop

System Snapshot

- Purpose** Insert snapshot of the current system into report
- Description** This component inserts a snapshot of the current system into the report.
- Snapshot**
- **Image file format:** Specifies the image file format (for example, JPEG or TIFF). Select `Automatic SL Format` (the default) to automatically choose the format best suited for the specified report output format. Otherwise, choose an image format that your output viewer can read. Options include:
 - `Automatic SL Format` (uses file format selected in the Preferences dialog box)
 - `Adobe Illustrator`
 - `Bitmap (16m-color)`
 - `Bitmap (256-color)`
 - `Black and white encapsulated PostScript`
 - `Black and white encapsulated PostScript (TIFF)`
 - `Black and white encapsulated PostScript2`
 - `Black and white encapsulated PostScript2 (TIFF)`
 - `Black and white PostScript`
 - `Black and white PostScript2`
 - `Color encapsulated PostScript`
 - `Color encapsulated PostScript (TIFF)`
 - `Color encapsulated PostScript2`
 - `Color encapsulated PostScript2 (TIFF)`
 - `Color PostScript`
 - `Color PostScript2`
 - `JPEG high quality image`
 - `JPEG medium quality image`

- JPEG low quality image
- PNG 24-bit image
- Scalable vector graphics (SVG)
- TIFF - compressed
- TIFF - uncompressed
- Windows metafile
- **Paper orientation:** Options include:
 - Largest dimension vertical
 - Landscape
 - Portrait
 - Use system orientation: The Use system orientation option uses the Simulink PaperOrientation parameter. For more information, see “Model Parameters” in the Simulink documentation.
- **Image Size:** Options include:
 - Automatic (default): Automatically scales the image to output dimensions.
 - Custom: Specifies image size.

Note If you select **Use printframe** , the Custom option is deactivated and the image is automatically scaled to the print frame size.

- **Use printframe:** Prints a frame around the image. You can use the default frame, `rptdefaultframe.fig`, or use the Frame Editor to build a custom frame. For more information, see `frameedit` in the Simulink documentation.

System Snapshot

The default frame is five inches wide and four inches high. It includes the name of the system and the model directory. This frame is optimized for use with a portrait paper orientation. The Flight Control Model in the f14 Simulink demo model appears here with the default Simulink Report Generator frame option.

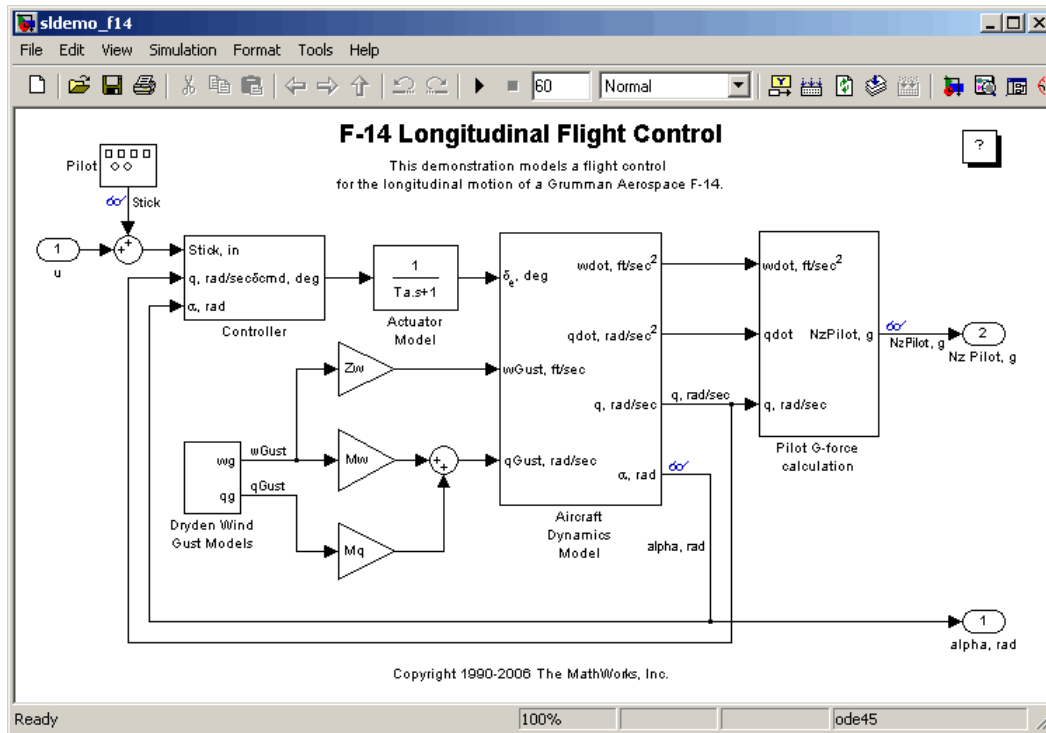

Display Options

- **Scaling:** Options include:
 - **Fixed size:** Specifies the number and type of units.
 - **Zoom:** Specifies the percentage, maximum size, and units of measure.

- **Use image size:** Causes the image to appear the same size in the report as on screen.
- **Size:** Specifies the size of the snapshot in the format `w h` (width height). This field is active only if you choose `Fixed size` in the **Scaling** selection list.
- **Max size:** Specifies the maximum size of the snapshot in the format `w h` (width height). This field is active only if you choose `Zoom` in the **Scaling** selection list.
- **Units:** Specifies the units for the size of the snapshot. This field is active only if you choose `Zoom` or `Fixed size` in the **Image size** list box.
- **Alignment:** Options include:
 - Auto
 - Right
 - Left
 - CenterOnly PDF and RTF reports support this option.
- **Image title:** Options include:
 - No title (Default)
 - System name: Uses the system name as the image name.
 - System name (full path): Uses the system name, with path information, as the image name.
 - Custom: Specifies a custom title.
- **Caption** Options include:
 - None (Default)
 - Description (use system description)
 - Custom: Specifies a custom caption.

System Snapshot

**Insert
Anything
into
Report?**

Yes. Image.

File Name

rptgen_sl.cs1_sys_snap

See Also

System Loop

Purpose

Capture plot figure created in the MATLAB workspace

Description

This component captures a plot figure created in the MATLAB workspace, and then inserts one or both of the following into the report:

- A table that includes input and output numeric values.
- A figure that plots the values included in the table.

Print Options

- **Image file format:** Specifies the image file format (for example, JPEG or TIFF) from this list. Select **Automatic HG Format** (the default) to automatically choose the format best suited for the specified report output format. Otherwise, choose an image format that your output viewer can read. Other options include:
 - Automatic HG Format (Uses the file format selected in the Preferences dialog box)
 - Adobe Illustrator
 - Bitmap (16m-color)
 - Bitmap (256-color)
 - Black and white encapsulated PostScript
 - Black and white encapsulated PostScript (TIFF)
 - Black and white encapsulated PostScript2
 - Black and white encapsulated PostScript2 (TIFF)
 - Black and white PostScript
 - Black and white PostScript2
 - Color encapsulated PostScript
 - Color encapsulated PostScript (TIFF)
 - Color encapsulated PostScript2
 - Color encapsulated PostScript2 (TIFF)
 - Color PostScript

To Workspace Plot

- Color PostScript2
- JPEG high quality image
- JPEG medium quality image
- JPEG low quality image
- PNG 24-bit image
- TIFF - compressed
- TIFF - uncompressed
- Windows metafile
- **Paper orientation:** Options include:
 - Landscape
 - Portrait
 - Rotated
 - Use figure orientation

For information about paper orientation, see the `orient` command in the MATLAB documentation.
- **Image size:**
 - Use figure `PaperPositionMode` setting: Uses the `PaperPositionMode` property of the Handle Graphics figure to set the image size in the report. For information about paper position mode, see the `orient` command in the MATLAB documentation.
 - Automatic (same size as on screen): Causes the image to appear the same size in the report as on screen.
 - Custom: Specifies a custom image size. Specify the image size in the `size` and `units` fields.
- **Size:** Specifies the size of the Handle Graphics figure snapshot in the format `wxh` (width times height). This field is active only if you choose Custom in the **Image size** list box.

- **Units:** Specifies units for the size of the Handle Graphics figure snapshot. This field is active only if you choose **Set image size** in the **Custom** list box.
- **Invert hardcopy:** Uses the Handle Graphics figures `InvertHardcopy` property, which inverts colors for printing; it changes dark colors to light colors and vice versa.

Select one of the following options:

- **Automatic:** Automatically changes dark axes colors to a light axes color. If the axes color is a light color, it is unchanged.
- **Invert:** Changes dark axes colors to light axes colors and vice versa.
- **Don't invert:** Retains image colors displayed on screen in the printed report.
- **Use figure's InvertHardcopy setting:** Uses the `InvertHardcopy` property set in the Handle Graphics image.
- **Make figure background transparent:** Makes the image background transparent.

Display Options

- **Scaling**
 - **Fixed size:** Specifies the number and type of units.
 - **Zoom:** Specifies the percentage, maximum size, and units of measure.
 - **Use image size:** Causes the image to appear the same size in the report as on screen.
- **Size:** Specifies the size of the snapshot in the format `w h` (width height). This field is active only if you choose **Fixed size** in the **Scaling** list.
- **Max size:** Specifies the maximum size of the snapshot in the format `w h` (width height). This field is active only if you choose **Zoom** from the **Scaling** list.

To Workspace Plot

- **Units:** Specifies units for the size of the snapshot. This field is active only if you choose `Zoom` or `Fixed` size in the **Image size** list box.
- **Alignment:** Options are:
 - Auto
 - Right
 - Left
 - CenterOnly PDF and RTF reports support this option.
- **Title:** Specifies text to appear above the snapshot.
- **Caption:** Specifies text to appear under the snapshot.

Insert Anything into Report?

Yes. Figure.

File Name

`rptgen_sl.csl_blk_toworkspace`

See Also

Figure Loop

Purpose

Report on truth tables in Simulink and Stateflow models

Description

The Truth Table component reports on truth tables in Simulink and Stateflow models. It displays both the condition table and the action table. The parent component of the Truth Table determines its behavior. Options include:

- **Model Loop:** Reports on all truth tables in the current model.
- **System Loop:** Reports on all truth tables in the current system.
- **Block Loop :** Reports on all truth tables in the current block.
- **Signal Loop:** Reports on all truth tables in the current signal.

Title

Title: Specifies a title for the truth table. Options include:

- **No title**
- **Use Stateflow name**
- **Custom**

Condition Table

Specify display parameters for the condition table. Options include:

- **Show header:** Displays the column headers in the table.
- **Show number:** Displays the condition number column in the table.
- **Show condition:** Displays the condition column in the table.
- **Show description:** Displays the description column in the table.
- **Wrap if column count:** Specifies how many columns to display before creating a table continuation. If the specified number is greater than the number of columns that can appear on the page, some columns do not appear in the report.

Action Table

- **Show header:** Displays the column headers in the table.
- **Show number:** Displays the condition number column in the table.

Truth Table

- **Show condition:** Displays the condition column in the table.
- **Show description:** Displays the description column in the table. If this option is not selected, no action table appears in the report.

Insert Anything into Report?

Yes. Table.

File Name

rptgen_sf.csf_truthtable

See Also

Block Loop, Model Loop, Signal Loop, System Loop

Function Reference

GUI (p. 9-2)

Report Generation (p. 9-3)

Web Views (p. 9-4)

Perform GUI-related tasks

Generate reports

Export Simulink models to Web Views

GUI

rptlist

Return list of all report templates in
MATLAB path

Report Generation

report

Generate report from specified
Simulink system

Web Views

slwebview

Export Simulink models to Web
views

Functions – Alphabetical List

report

Purpose Generate report from specified Simulink system

Syntax `report (system_name)`

Description `report (system_name)` generates a report from the specified Simulink system. If the specified system's `ReportName` property is empty, the `ReportName` property of its parent system is used instead.

See Also `report`, Generating Reports

- Purpose** Return list of all report templates in MATLAB path
- Syntax** `rptlist ('system_name')`
- Description** `rptlist ('system_name')` opens the Report Explorer with the Simulink system's `ReportName` property selected.
- See Also** `report`, `setedit`

slwebview

Purpose Export Simulink models to Web views

Syntax

```
slwebview
filename = slwebview(system_name)
... = slwebview(system_name, 'option1', value1, ...)
```

Description This function creates an interactive Web view of a Simulink model. For more information about Web views, see [Exporting Simulink Models to Web Views](#).

- `slwebview` with no arguments starts the Web View dialog box in the Report Explorer.
- `filename = slwebview(system_name)` exports the subsystem `system_name` and its child systems to the file `filename`.

You can specify `system_name` as:

- A string
- A handle to a Simulink subsystem or block diagram
- A handle to a Stateflow chart or subchart
- `... = slwebview(system_name, 'option1', value1, ...)` sets Web view export options. For more information, see “Export Options” on page 10-4.

Export Options

The first argument passed to the `slwebview` command is the name (a string) or a handle identifying the Simulink system or Stateflow chart to export. Remaining arguments are alternating name and value pairs (strings) that set export options.

SearchScope

Specifies which Simulink systems or Stateflow charts to export.

'SearchScope' Option Value	Meaning
Current	Export only the Simulink system or the Stateflow chart specified by the first argument
CurrentAndAbove	Export the Simulink system or the Stateflow chart specified by the first argument and all systems or charts that contain it
CurrentAndBelow (Default)	Export the Simulink system or the Stateflow chart specified by the first argument and all systems or charts that it contains
All	Export all Simulink systems or Stateflow charts in the model that contains the system or chart specified by the first argument

LookUnderMasks

This option is relevant only when you are exporting Simulink subsystems or Stateflow subcharts that the specified system or chart contains. It specifies which masked blocks, if any, in subsystems or subcharts to export.

'LookUnderMasks' Option Value	Meaning
None	Do not export any masked blocks
Graphical (Default)	Export only masked blocks that have no workspaces and no dialog boxes
Functional	Export only masked blocks that have no dialog boxes
All	Export all masked blocks

FollowLinks

Specifies whether to follow links into library blocks.

'FollowLinks' Option Value	Meaning
On	Follow links into library blocks
Off (Default)	Do not follow links into library blocks

FollowModelReferenceBlocks

Specifies whether to follow links into referenced models.

'FollowModelReferenceBlocks' Option Value	Meaning
On	Follow links into referenced models
Off (Default)	Do not follow links into referenced models

ViewFile

Specifies whether to display the Web view in a Web browser.

'ViewFile' Option Value	Meaning
true (Default)	Display the Web view in a Web browser
false	Do not display the Web view in a Web browser

See Also

Exporting Simulink Models to Web Views

Examples

Use this list to find examples in the documentation.

Creating Reports

Chapter 2, “Creating Simulink Reports”

“How to Compare XML Files Exported from Simulink Models” on page 6-2

Generating Reports from M-files

Generating Reports from M-files on page 3-15

Creating Web Views

“Tutorial: Creating Web Views of Simulink Models” on page 4-11

Working with Components

“Working with Looping Components” on page 5-3

“Working with Property Table Components” on page 5-9

“Working with Summary Table Components” on page 5-21

Generating Reports on Specified Systems and their Subsystems on page 8-43

Temporarily Omitting a Model from a Loop on page 8-49

A

Annotation Loop component 8-2

B

Block Execution Order List component 8-4

Block Loop component 8-5

Block Type Count component 8-8

Bus component 8-10

C

Chart Loop component 8-12

Code Generation Summary component 8-15
component

 Stateflow Name 8-113

components

 about 5-2

 Annotation Loop 8-2

 Block Execution Order List 8-4

 Block Loop 8-5

 Block Type Count 8-8

 Bus 8-10

 Chart Loop 8-12

 Code Generation Summary 8-15

 Documentation 8-17

 Fixed Point Block Loop 8-20

 Fixed Point Logging Options 8-22

 Fixed Point Property Table 8-25

 Fixed Point Summary Table 8-28

 Import Generated Code 8-31

 Look-Up Table 8-32

 looping components

 about 5-3

 Model Advisor Report 8-38

 Model Change Log 8-39

 Model Loop 8-41

 Model Simulation 8-54

 Object Loop 8-56

 Real-Time Workshop 7-2

Requirement System Loop 8-60

Requirements Block Loop 8-58

Requirements Management Interface
 components 7-3

Requirements Summary Table 8-62

Requirements Table 8-65

Scope Snapshot 8-66

Signal Loop 8-71

Simulink Automatic Table 8-74

Simulink Blocks components 7-7

Simulink components 7-4

Simulink Dialog Snapshot 8-76

Simulink Fixed Point components 7-8

Simulink Functions and Variables 8-78

Simulink Library Information 8-82

Simulink Linking Anchor 8-86

Simulink Name 8-88

Simulink Property 8-90

Simulink Property Table 8-92

Simulink Sample Time 8-96

Simulink Summary Table 8-97

State Loop 8-101

Stateflow Automatic Table 8-103

Stateflow components 7-9

Stateflow Count 8-105

Stateflow Dialog Snapshot 8-106

Stateflow Filter 8-108

Stateflow Hierarchy 8-109

Stateflow Hierarchy Loop 8-111

Stateflow Linking Anchor 8-112

Stateflow Property 8-114

Stateflow Property Table 8-116

Stateflow Snapshot 8-119

Stateflow Summary Table 8-124

System Filter 8-127

System Hierarchy 8-128

System Loop 8-130

System Snapshot 8-132

To Workspace Plot 8-137

Truth Table 8-141

- components,
 - Machine Loop 8-37
- converting English strings to other languages 3-9
- converting XML documents
 - using Report Explorer 3-11
 - using the command line 3-13
- converting XML documents to different format 3-11

D

- DocBook SGML report 3-5
- Documentation component 8-17

F

- Fixed Point Block Loop component 8-20
- Fixed Point Logging Options component 8-22
- Fixed Point Property Table component 8-25
- Fixed Point Summary Table component 8-28
- flow object tree (XML) 3-5
- functions
 - report 10-2
 - rptlist 10-3
 - slwebview 10-4

H

- Handle Graphics
 - creating figures 5-3
 - figure property table 5-9
 - HandleVisibility 5-4
 - invisible figures 5-3
 - tags 5-4
- HTML report
 - stylesheets 3-5

I

- Import Generated Code component 8-31

L

- legacy report templates
 - working with 3-18
- localization 3-9
- log files
 - creating 3-14
- Look-Up Table component 8-32
- looping components
 - about 5-3

M

- M-code
 - generating from report templates 3-15
- Machine Loop component 8-37
- Microsoft Word report 3-5
- Model Advisor Report component 8-38
- Model Change Log component 8-39
- Model Loop component 8-41
- Model Simulation component 8-54

O

- Object Loop component 8-56

P

- property tables
 - adding and deleting columns and rows 5-19
 - creating custom tables 5-20
 - displaying or hiding table and cell borders 5-18
 - editing table titles 5-16
 - entering text into table cells 5-16
 - modifying properties in a table 5-17
 - property name/property value pairs 5-12

R

- Real-Time Workshop components 7-2
- Report Explorer

- About 1-3
- Options pane 1-6
- Outline pane 1-5
- Properties pane 1-7
- report formats 1-11
- report function 10-2
- report templates
 - autosaving on report generation 3-9
- reports
 - descriptions 3-9
 - generating 3-1
 - preferences 3-2
 - printing 3-8
 - setting output options 3-2
- Requirement System Loop component 8-60
- Requirements Block Loop component 8-58
- Requirements Management Interface
 - components 7-3
- Requirements Summary Table component 8-62
- Requirements Table component 8-65
- rich text format 3-5
- rptlist function 10-3

S

- Scope Snapshot component 8-66
- SGML report 3-5
- Signal Loop component 8-71
- Simulink Automatic Table component 8-74
- Simulink Blocks components 7-7
- Simulink components 7-4
- Simulink Dialog Snapshot component 8-76
- Simulink Fixed Point components 7-8
- Simulink Functions and Variables
 - component 8-78
- Simulink Library Information component 8-82
- Simulink Linking Anchor component 8-86
- Simulink Name component 8-88
- Simulink Property component 8-90
- Simulink Property Table component 8-92
- Simulink Report Generator software
 - components
 - definition 2-5
 - creating reports 2-1
 - generating reports 3-1
 - interaction with MATLAB and Simulink 1-10
 - overview 1-2
 - report formats 1-11
 - report templates
 - adding components to 2-5
 - setting report options 2-3
 - tutorial 2-1
 - workflow 1-9
- Simulink Sample Time component 8-96
- Simulink Summary Table component 8-97
- slwebview function 10-4
- State Loop component 8-101
- Stateflow Automatic Table component 8-103
- Stateflow components 7-9
- Stateflow Count component 8-105
- Stateflow Dialog Snapshot component 8-106
- Stateflow Filter component 8-108
- Stateflow Hierarchy component 8-109
- Stateflow Hierarchy Loop component 8-111
- Stateflow Linking Anchor component 8-112
- Stateflow Name component 8-113
- Stateflow Property component 8-114
- Stateflow Property Table component 8-116
- Stateflow Snapshot component 8-119
- Stateflow Summary Table component 8-124
- stylesheets 3-5
 - HTML 3-7
 - PDF 3-5
 - RTF (DSSSL Print) and Word 3-8
 - Web 3-7
- Summary Table components
 - working with 5-21
- System Filter component 8-127
- System Hierarchy component 8-128

System Loop component 8-130
System Snapshot component 8-132

T

To Workspace Plot component 8-137
troubleshooting 3-20
Truth Table component 8-141

W

Web stylesheet 3-5
Web views
 browser requirements 1-12
 exporting Simulink models 4-3
 setting export options 4-3
 generating 4-5
 navigating 4-7
 overview 4-2

tutorial 4-11
viewing 4-5

X

XML comparison
 introduction 6-2
 report 6-8
 reverse annotation 6-10
 selecting files 6-4
XML documents
 converting to different format 3-11
 converting to different formats
 using Report Explorer 3-11
 using the command line 3-13
XML report 3-5
XML source files
 editing 3-13